

SQUARE AA NSP/4

recessed square LED narrow spot accent light

FULLY SUSTAINABLE – FULLY SUSTAINABLE – FULLY SUSTAINABLE – FULLY SUSTAINABLE – FULLY SUSTAINABLE – FULLY SUSTAINABLE – FULLY SUSTAINABLE

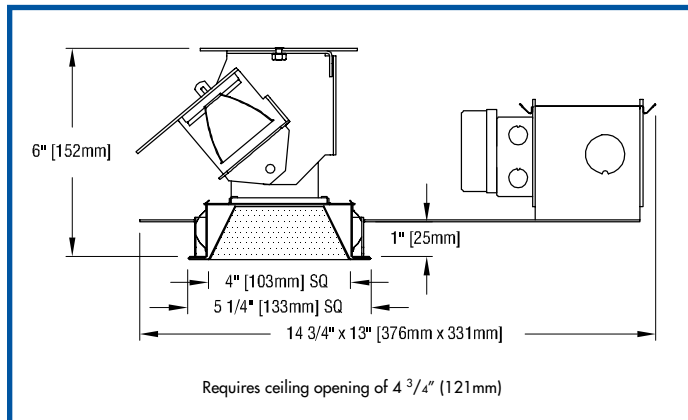

FEATURES

- SQUARE AA NSP/4 is a 4" square LED narrow spot accent light.** Luminaire is powered by one of a number of Xicato XTM (9mm) LED modules, distinguished by extraordinary color consistency (within 1x2-step MacAdam ellipse). See tables on pages below for wattages and efficacies.
- Luminaire overall depth is 6"** (housing depth of 5" plus a 1" throat).
- Luminaire employs an internal 'twist and lock' internal reflector** to produce an initial beamspread of 14° or 24°. To allow beamspread to be changed in installed luminaires, internal reflectors are available as accessories.
- Luminaire provides full circle rotation and 0° - 35° angular adjustment.** Once focused, adjustment may be locked by means of a thumb screw and a wing nut.
- Precise reflector design minimizes aperture brightness** and virtually eliminates the inter-reflections inherent with square apertures. External reflector is designed to accept either a Solite-pattern prismatic lens (-PRS) or a clear glass (-GLS) mounted in the top aperture.
- External reflectors are available in two clear natural aluminum finishes** – slightly diffuse (V) or fully diffuse (EC) – as well as black and white.
- Housing is constructed from 14-gauge and 16-gauge electro-zinc steel** in Edison Price Lighting's American factory. Heavy-gauge metals and American manufacturing guarantee long-lasting durability.
- Luminaires includes a pair of 3/4" x 27" C channel mounting bars.**
- For more information, [click here](#).**

APPLICATIONS

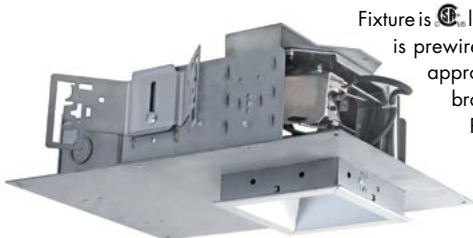

Fixture is  listed for Damp Location. Fixture is wired with thermal protector and approved for eight #12 wire 90° branch circuit pull-through wiring. Removal of the external reflector trim allows access to the LED module and junction box.

SPACING

Six models – L07A, L10A, L10S, L10V, L13S and L13V – must be spaced 30" apart and 15" from walls with 1/2" clearance above housing.

For **Trimless Square aperture** model, see [PRIM SQUARE AA NSP/4](#).
For **shallower depths and lower pricing**, see [WAFER SQUARE/4 AA](#).

PRODUCT CODE

For complete product code, list basic unit and select one item from each following box.

Basic Unit	S4-XTS-AA
Driver Choose one.	
dimmable to 1% by a 0-10V dimmer on 120 or 277-volt service	DMV
dimmable to 5% or 10% (see Light Output box below) by either an incandescent or ELV dimmer; 120-volt service only	DMP
eldoLED 0-10V (Logarithmic) driver dimmable to 0.1% with a 0-10V dimmer on 120 or 277-volt service	DVOELG
eldoLED 0-10V (Linear) driver dimmable to 0.1% with a 0-10V dimmer on 120 or 277-volt service	DVOELN
eldoLED driver dimmable to 0.1%, compatible with DALI control system	DA0-EL
Moons' driver dimmable to 0.1%, compatible with DMX controllers	DX0

Light Source Output (Lumens) Choose one.

700L / CRI 98 Artist	see SPACING	DMP (5%)	L07A	
700L / CRI 80+	see SPACING	DMP (10%)	L07S	
700L / CRI 80+ Vibrant	see SPACING	DMP (10%)	L07V	
1000L / CRI 98 Artist	see SPACING	DMP (5%)	L10A	
1000L / CRI 80+	see SPACING	DMP (5%)	L10S	
1000L / CRI 80+ Vibrant	see SPACING	3000K only	DMP (5%)	L10V
1300L / CRI 80+	see SPACING	DMP (5%)	L13S	
1300L / CRI 80+ Vibrant	see SPACING	3000K only	DMP (5%)	L13V

Light Color Choose one.

2700 K	- 27K
3000 K	- 30K
3500 K	- 35K
4000 K	- 40K

Internal Reflector Choose one.

14° initial beamspread	- 14D
24° initial beamspread	- 24D

Voltage Choose one.

120 volt service	- 120
277 volt service	- 277

External Reflector Lens Choose one.

Solite prismatic lens	- PRS
Clear glass	- GLS

Reflector Color and Detail

Slightly diffuse Clear	Overlap VOL
Champagne Gold	GOL
Black	BOL
Specular White	WOL

Other reflector finishes available on special order.
Standard reflector flange continues reflector finish. White painted flanges and custom painted flanges are available on special order. Add WF (white flange) or CCF (custom color flange).

OPTIONS Specify by adding to the basic unit.

Remote emergency battery pack including two components – battery pack and plate with test switch and light – to be mounted adjacent to luminaire; for use in accessible ceilings	- RX
---	------

EXTRA REFLECTORS Specify as separate line items.

14° initial beamspread	XTM-REF14D
24° initial beamspread	XTM-REF24D



PHOTOMETRIC REPORT with 14° reflector and prismatic lens (PRS) (tested per IESNA LM-79-2008)

Verification Services Report No. 1183619. Original test report furnished upon request.

Luminaire recessed LED square narrow spot accent light with slightly diffuse clear aluminum reflector covered with prismatic lens (PRS)
 Light Source one white Xicato XTM 9mm LES LED with 14° beam spread integral reflector, 3000K CCT, 80 CRI, 1300 lumens
 Lamp Life rated 50,000 hours based on L70/B50 criteria. LM80 report by LED manufacturer furnished upon request

CANDLEPOWER DISTRIBUTION (Candela)

Vertical Angle	Horizontal Angle				
	0	45	90	135	180
0	1002	1002	1002	1002	1002
5	2082	1562	905	648	555
15	7421	1665	532	220	56
25	2202	742	112	17	11
35	79	80	10	4	5
45	5	5	2	1	4
55	1	0	1	0	4
65	0	0	0	0	0
75	0	0	0	0	0
85	0	0	0	0	0
90	0	0	0	0	0

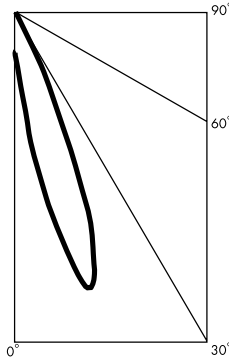

LUMINAIRE LIGHT OUTPUT AND EFFICACY

LED Light Engine	Luminaire Light Output	Luminaire CBCP	Luminaire Efficacy (lms/watt)	System Wattage	RX Light Output (90 min. run)
700 Lumens Artist	424*	4077*	25	17	154*
1000 Lumens Artist	552*	5311*	26*	21	154*
700 Lumens standard & Vibrant	440*	4235*	36*	12	231*
1000 Lumens standard & Vibrant	584*	5621*	34*	17	231*
1300 Lumens standard & Vibrant	771	7421	37	21	231*

*estimated values

PHOTOMETRIC REPORT with 24° reflector and prismatic lens (PRS) (tested per IESNA LM-79-2008)

Verification Services Report No. 1183621. Original test report furnished upon request.

Luminaire recessed LED square narrow spot accent light with slightly diffuse clear aluminum reflector covered with prismatic lens (PRS)
 Light Source one white Xicato XTM 9mm LES LED with 24° beam spread integral reflector, 3000K CCT, 80 CRI, 1300 lumens
 Lamp Life rated 50,000 hours based on L70/B50 criteria. LM80 report by LED manufacturer furnished upon request

CANDLEPOWER DISTRIBUTION (Candela)

Vertical Angle	Horizontal Angle				
	0	45	90	135	180
0	1434	1434	1434	1434	1434
5	2324	1967	1308	922	748
15	3852	2019	691	237	61
25	2244	983	118	19	12
35	262	102	10	6	5
45	8	6	3	1	4
55	1	0	1	0	4
65	0	0	0	0	0
75	0	0	0	0	0
85	0	0	0	0	0
90	0	0	0	0	0

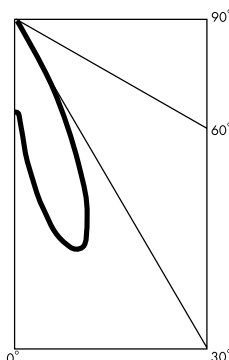

LUMINAIRE LIGHT OUTPUT AND EFFICACY

LED Light Engine	Luminaire Light Output	Luminaire CBCP	Luminaire Efficacy (lms/watt)	System Wattage	RX Light Output (90 min. run)
700 Lumens Artist	427*	2116*	25	17	155*
1000 Lumens Artist	556*	2757*	27*	21	155*
700 Lumens standard & Vibrant	443*	2198*	36*	12	233*
1000 Lumens standard & Vibrant	588*	2918*	34*	17	233*
1300 Lumens standard & Vibrant	777	3852	37	21	233*

*estimated values

PHOTOMETRIC REPORTS CONTINUE BELOW



PHOTOMETRIC REPORT with 14° reflector and clear glass (GLS) (tested per IESNA LM-79-2008)

UL Verification Services Report No. 1183618. Original test report furnished upon request.

Luminaire recessed LED square narrow spot accent light with slightly diffuse clear aluminum reflector covered with clear glass (GLS)
 Light Source one white Xicato XTM 9mm LES LED with 14° beam spread integral reflector, 3000K CCT, 80 CRI, 1300 lumens
 Lamp Life rated 50,000 hours based on L70/B50 criteria. LM80 report by LED manufacturer furnished upon request

CANDLEPOWER DISTRIBUTION (Candela)

Vertical Angle	Horizontal Angle				
	0	45	90	135	180
0	905	905	905	905	905
5	1803	1356	815	590	526
15	8181	1559	512	92	23
25	2367	751	75	11	8
35	87	53	9	3	4
45	5	6	2	1	3
55	0	0	1	0	4
65	0	0	1	0	0
75	0	0	0	0	0
85	0	0	0	0	0
90	0	0	0	0	0

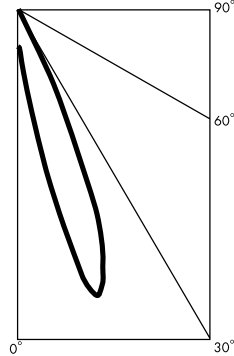

LUMINAIRE LIGHT OUTPUT AND EFFICACY

LED Light Engine	Luminaire Light Output	Luminaire CBCP	Luminaire Efficacy (lms/watt)	System Wattage	RX Light Output (90 min. run)
700 Lumens Artist	425*	4495*	25*	17	155*
1000 Lumens Artist	553*	5855*	27*	21	155*
700 Lumens standard & Vibrant	441*	4669*	36*	12	232*
1000 Lumens standard & Vibrant	586*	6197*	34*	17	232*
1300 Lumens standard & Vibrant	773	8181	37	21	232*

*estimated values

PHOTOMETRIC REPORT with 24° reflector and clear glass (GLS) (tested per IESNA LM-79-2008)

UL Verification Services Report No. 1183620. Original test report furnished upon request.

Luminaire recessed LED square narrow spot accent light with slightly diffuse clear aluminum reflector covered with clear glass (GLS)
 Light Source one white Xicato XTM 9mm LES LED with 24° beam spread integral reflector, 3000K CCT, 80 CRI, 1300 lumens
 Lamp Life rated 50,000 hours based on L70/B50 criteria. LM80 report by LED manufacturer furnished upon request

CANDLEPOWER DISTRIBUTION (Candela)

Vertical Angle	Horizontal Angle				
	0	45	90	135	180
0	1398	1398	1398	1398	1398
5	2338	1939	1263	853	723
15	4082	2024	666	123	32
25	2394	1005	85	14	10
35	260	68	8	5	4
45	5	5	2	1	3
55	0	0	1	0	3
65	0	0	0	0	0
75	0	0	0	0	0
85	0	0	0	0	0
90	0	0	0	0	0

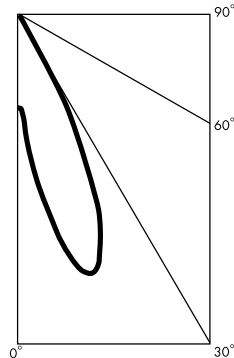

LUMINAIRE LIGHT OUTPUT AND EFFICACY

LED Light Engine	Luminaire Light Output	Luminaire CBCP	Luminaire Efficacy (lms/watt)	System Wattage	RX Light Output (90 min. run)
700 Lumens Artist	429*	2243*	25*	17	156*
1000 Lumens Artist	559*	2921*	27*	21	156*
700 Lumens standard & Vibrant	446*	2330*	36*	12	234*
1000 Lumens standard & Vibrant	591*	3092*	34*	17	234*
1300 Lumens standard & Vibrant	781	4082	37	21	234*

*estimated values

STANDARD DMV DRIVER INFORMATION (UL Class 2, dry and damp location)

Voltage	120	277
Input Watts (L07A/L10A /L07S&V/L10S&V/L13S&V)	17/21/12/17/21	17/21/12/17/21
Input Current (A) (L07A/L10A /L07S&V/L10S&V/L13S&V)	.14/.18/.10/.14/.18	.06/.08/.04/.06/.08
Output Current (mA)	350-700	350-700
Min. Power Factor	.99	.99
Operating Temperature Range (F)	-13 to 122	-13 to 122

LIGHT OUTPUT MULTIPLIER

LED Light Engine	Light Output Multiplier	RX Light Output Multiplier
700 Lumens Artist	.55*	.20*
1000 Lumens Artist	.72*	.20*
700 Lumens standard & Vibrant	.57*	.30*
1000 Lumens standard & Vibrant	.76*	.30*
1300 Lumens standard & Vibrant	1	.30*

*estimated values

REFLECTOR COLOR MULTIPLIERS

Slightly diffuse clear (V)	1
Fully diffuse clear (EC)	.90
Specular White (W)	.70
Black (B)	.40