

Project

Type



Date

Product Code

Designer

WAFER PRIM SQUARE/3 AA

recessed shallow trimless square LED accent light

FULLY SUSTAINABLE – FULLY SUSTAINABLE – FULLY SUSTAINABLE – FULLY SUSTAINABLE – FULLY SUSTAINABLE – FULLY SUSTAINABLE – FULLY SUSTAINABLE

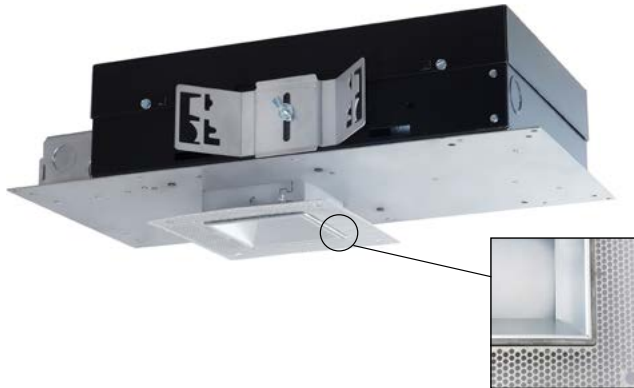

FEATURES

- **WAFER PRIM SQUARE/3 AA is a trimless, square LED accent light** with an overall depth of 4 3/4" (housing depth of 3 3/4" plus a 1" throat).
- **Luminaire is exclusively designed for installation in sheet rock** to achieve a flush trim detail. Installation includes the application of drywall compound over the luminaire's integral spackle screen to the rim of its integral plaster ring.
- **Luminaire provides 365° rotation and 0°-30° angular adjustment.** Once focused, adjustment may be locked by a lever and a thumb nut.
- **Luminaire employs an internal 'twist and lock' lens** to produce an initial beam-spread of either 12°, 20° or 36°. To allow beamspread to be changed in installed luminaires, internal lenses are available as accessories.
- **Luminaire accepts one of a number of Optical Accessories** including lenses and color filters.
- **External reflector is designed to accept** a clear glass (-GLS) or a Solite-pattern prismatic lens (-PRS). External reflectors are available in two clear natural aluminum finishes – slightly diffuse (V) or fully diffuse (EC) – as well as black and white.
- **Housing is constructed from 20-gauge electro-zinc, polyester-coated steel** in Edison Price Lighting's American factory. Heavy-gauge metals and American manufacturing guarantee long-lasting durability.
- **Optional housing design for residential installation** in wood joist ceilings (-RI).
- **WAFER PRIM SQUARE/3 AA includes a pair of mounting bars** (3/4" x 27" C channel). Specialty bars for wood and T-bar installations are also available.
- **For more information, [click here](#).**

APPLICATIONS

Luminaire is listed as an inherently protected luminaire for Damp Location. Luminaire is RoHS compliant, is suitable for use in a fire rated ceiling. Removal of the external reflector allows access to the LED module and junction box.



ENERGY STAR
Energy Star qualified under Luminaires Specification V2.0. See Energy Star website for model numbers included in listing. The following options are not qualified: L08H, L15S, 12D, 20D, and ZGOMAG. On orders which require Energy Star labelling, add "-ESL" to the specified Product Code.

PRODUCT CODE

For complete product code, list basic unit and select one item from each following box.

Basic Unit standard installation design WP3-CLT-AA

Internal Lens *Choose one.*

- 12° initial beamspread - 12D
- 20° initial beamspread - 20D
- 36° initial beamspread - 36D

Light Source Output (Lumens)

- 800 lumens / CRI 90+ 4000K not available - L08H
- 1000 lumens 4000K not available - L10H
- 1200 lumens 4000K not available - L12H
- 1000 lumens / CRI 80+ - L10S
- 1200 lumens - L12S
- 1500 lumens - L15S

Driver

- dimmable to 1% by a 0-10V dimmer on 120 Or 277-volt service - DMV
- dimmable to 5% by either an incandescent or electronic low voltage dimmer only; 120-volt service only - DMP
- dimmable to 1% by a 2-wire Lutron compatible dimmer - DMHU
- dimmable to 1% SoftOn/FadeToBlack by a Lutron EcoSystem control ... - ECO-LU
- elddLED 0-10V (Logarithmic) driver dimmable to 0.1% with a 0-10V dimmer - DV0ELG
- elddLED 0-10V (Linear) driver dimmable to 0.1% with a 0-10V dimmer - DV0ELN
- elddLED driver dimmable to 0.1% with DALI control system - DA0-EL
- dimmable to 0.1% by a Zigbee wireless network (Daintree, Encelium or Wink); wireless range 50' through standard walls; available with L12H or L15S models only - ZGOMAG

Light Color

- 2700 K - 27K
- 3000 K - 30K
- 3500 K - 35K
- 4000 K - 40K

External Reflector Color & Trim	GLS Clear Glass	PRS Prismatic Lens
Slightly diffuse clear	GLS-VTL	PRS-VTL
Diffuse clear	GLS-ECTL	PRS-ECTL
Black	GLS-BTL	PRS-BTL
White	GLS-WTL	PRS-WTL

OPTIONS *Specify by adding to the basic unit.*

- Housing designed for residential installation** (see next page) including a pair of mounting bars (extendable to 20") for use between wood joists. - RI
- Millwork trim detail** consists of an aperture collar (see below) and an external reflector (see above).
 - milled aluminum aperture collar - M
 - white aperture collar - MWH
 - black aperture collar - MBL
 - custom color aperture collar - MCC
- Energy Star labelling** available on some models; see the Energy Star info 'box' on this page - ESL

EXTRA INTERNAL LENSES *Specify as separate line items.*

- 12° internal lens CLT-LENS12-50
- 20° internal lens CLT-LENS20-50
- 36° internal lens CLT-LENS36-50



OPTICAL ACCESSORIES

Specify as separate line

All are 2 3/4" (70mm) diameter.

diffuse glass	DGS/2.375
prismatic lens (Solite)	PLS/2.375
55° spread lens	LENS/2.375
40° x 70° spread lens	LENS/2.375-4070
beam smoother	DIF05/2.375
33% light reduction screen	SCR33/2.375
50% light reduction screen	SCR50/2.375
color filters	
surprise pink	PNK/2.375
daylight blue	DAY/2.375
amber	AMB/2.375
blue	BLU/2.375
green	GRN/2.375
red	RED/2.375

RESIDENTIAL INSTALLATION DESIGN (-RI)

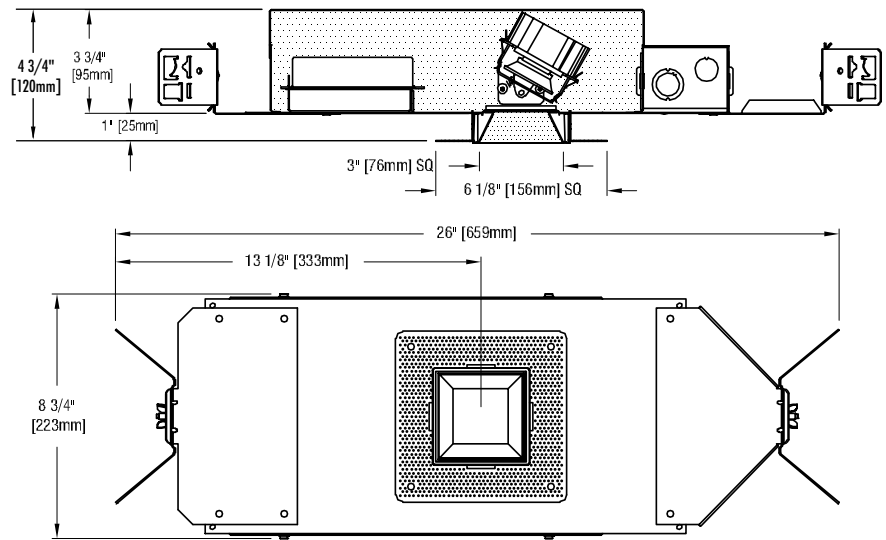

STANDARD INSTALLATION DESIGN

Requires ceiling opening of 4" (102mm) square in a drywall ceiling.
Requires ceiling opening of 3.4" (87mm) square in a (metal or wood) millwork ceiling.

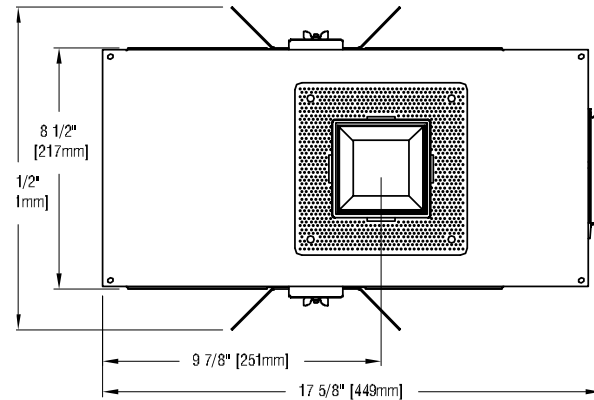
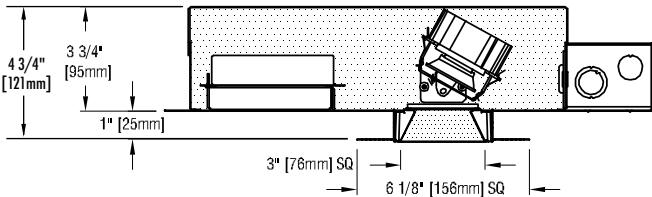

STANDARD DMV DRIVER INFORMATION (UL Class 2, dry and damp location)

Voltage	120	277
Input Watts (I108H/I10H/I12H/I10S/I12S/I15S)	9/10/13/9/10/13	9/10/13/9/10/13
Input Current (A) (I108H/I10H/I12H/I10S/I12S/I15S)	08/08/11/08/08/11	04/04/06/04/04/06
Output Current (mA)	220-350	220-350
Min. Power Factor	.99	.99
Operating Temperature Range (F)	-13 to 122	-13 to 122

LIGHT OUTPUT MULTIPLIER

LED Light Engine	Light Output Multiplier
800 Lumens 90 CRI	0.84*
1000 Lumens 90 CRI	1
1200 Lumens 90 CRI	1.23*
1000 Lumens 80 CRI	1.04*
1200 Lumens 80 CRI	1.24*
1500 Lumens 80 CRI	1.53*

*estimated values

REFLECTOR COLOR MULTIPLIERS

Slightly diffuse clear (V)	1
Fully diffuse clear (EC)	.90
Specular white (W)	.70
Black (B)	.40

– photometrics continued below –



PHOTOMETRIC REPORT with 12° internal lens and clear glass (GLS) (tested per IESNA LM-79-2008)

Prorated from Verification Services Report No. 12269958.01. Original test report furnished upon request.

Luminaire recessed LED square accent light with semi-specular clear aluminum reflector and clear glass, LED aimed at 15° above vertical.+
 Light Source Cree CXB1310 LED with 12° beam spread integral lens, 2700K CCT, 90 CRI, 1000 lumens

CANDLEPOWER DISTRIBUTION (Candela)

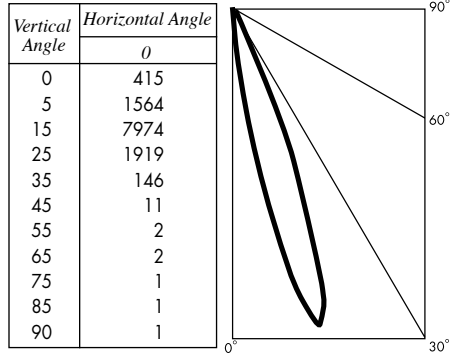

LUMINAIRE LIGHT OUTPUT AND EFFICACY

LED Light Engine	Luminaire Light Output	Luminaire CBCP	Luminaire Efficacy (lms/watt)	System Wattage
800 Lumens 90 CRI	489*	6698*	55*	9
1000 Lumens 90 CRI	582	7974	55	10
1200 Lumens 90 CRI	716*	9808*	55*	13
1000 Lumens 80 CRI	605*	8293*	67*	9
1200 Lumens 80 CRI	722*	9888*	72*	10
1500 Lumens 80 CRI	890*	12,200*	68*	13

*estimated values

PHOTOMETRIC REPORT with 12° internal lens and prismatic lens (PRS) (tested per IESNA LM-79-2008)

Prorated from Verification Services Report No. 12269958.02. Original test report furnished upon request.

Luminairerecessed LED square accent light with semi-specular clear aluminum reflector and prismatic lens, LED aimed at 15° above vertical.+
 Light SourceCree CXB1310 LED with 12° beam spread integral lens, 2700K CCT, 90 CRI, 1000 lumens

CANDLEPOWER DISTRIBUTION (Candela)

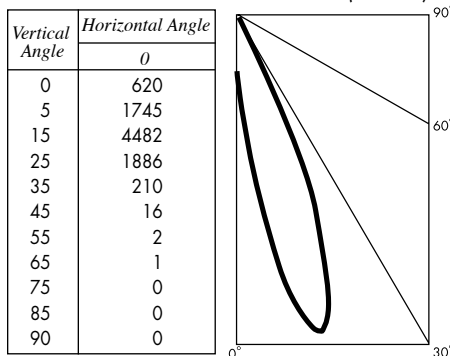

LUMINAIRE LIGHT OUTPUT AND EFFICACY

LED Light Engine	Luminaire Light Output	Luminaire CBCP	Luminaire Efficacy (lms/watt)	System Wattage
800 Lumens 90 CRI	474*	3765*	53*	9
1000 Lumens 90 CRI	564	4482	54	10
1200 Lumens 90 CRI	694*	5513*	53*	13
1000 Lumens 80 CRI	587*	4661*	65*	9
1200 Lumens 80 CRI	699*	5558*	70*	10
1500 Lumens 80 CRI	863*	6857*	66*	13

*estimated values

PHOTOMETRIC REPORT with 20° internal lens and clear glass (GLS) (tested per IESNA LM-79-2008)

Prorated from Verification Services Report No. 12269958.03. Original test report furnished upon request.

Luminairerecessed LED square accent light with semi-specular clear aluminum reflector and clear glass, LED aimed at 15° above vertical.+
 Light SourceCree CXB1310 LED with 20° beam spread integral lens, 2700K CCT, 90 CRI, 1000 lumens

CANDLEPOWER DISTRIBUTION (Candela)

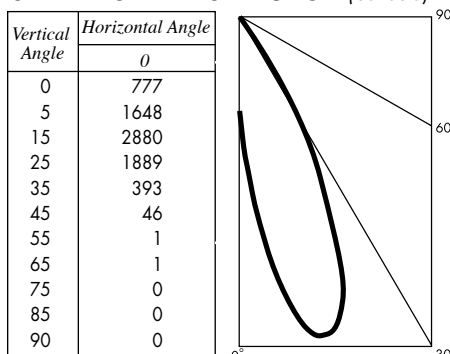

LUMINAIRE LIGHT OUTPUT AND EFFICACY

LED Light Engine	Luminaire Light Output	Luminaire CBCP	Luminaire Efficacy (lms/watt)	System Wattage
800 Lumens 90 CRI	491*	2419*	55*	9
1000 Lumens 90 CRI	584	2880	56	10
1200 Lumens 90 CRI	718*	3542*	55*	13
1000 Lumens 80 CRI	607*	2995*	67*	9
1200 Lumens 80 CRI	724*	3571*	72*	10
1500 Lumens 80 CRI	894*	4406*	69*	13

*estimated values

PHOTOMETRIC REPORT with 20° internal lens and prismatic lens (PRS) (tested per IESNA LM-79-2008)

Prorated from Verification Services Report No. 12269958.04. Original test report furnished upon request.

Luminaire recessed LED square accent light with semi-specular clear aluminum reflector and prismatic lens, LED aimed at 15° above vertical.+
Light Source Cree CXB1310 LED with 20° beam spread integral lens, 2700K CCT, 90 CRI, 1000 lumens

CANDLEPOWER DISTRIBUTION (Candela)

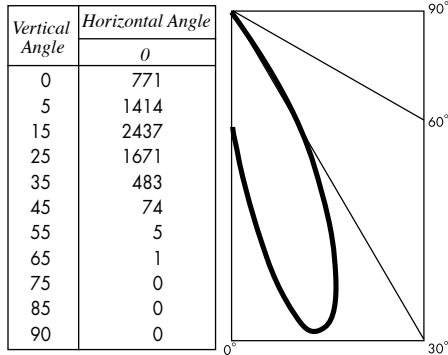

LUMINAIRE LIGHT OUTPUT AND EFFICACY

LED Light Engine	Luminaire Light Output	Luminaire CBCP	Luminaire Efficacy (lms/watt)	System Wattage
800 Lumens 90 CRI	486*	2047*	54*	9
1000 Lumens 90 CRI	579	2437	55	10
1200 Lumens 90 CRI	712*	2998*	55*	13
1000 Lumens 80 CRI	602*	2534*	67*	9
1200 Lumens 80 CRI	718*	3022*	72*	10
1500 Lumens 80 CRI	886*	3729*	68*	13

*estimated values

PHOTOMETRIC REPORT with 36° internal lens and clear glass (GLS) (tested per IESNA LM-79-2008)

Prorated from Verification Services Report No. 12269958.05. Original test report furnished upon request.

Luminaire recessed LED square accent light with semi-specular clear aluminum reflector and clear glass, LED aimed at 15° above vertical.+
Light Source Cree CXB1310 LED with 36° beam spread integral lens, 2700K CCT, 90 CRI, 1000 lumens

CANDLEPOWER DISTRIBUTION (Candela)

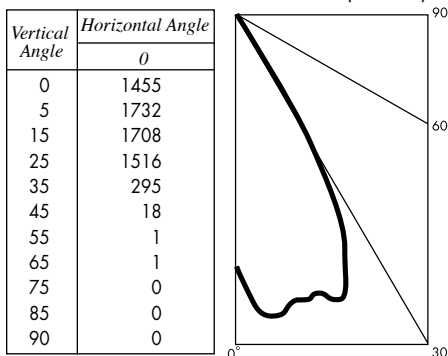

LUMINAIRE LIGHT OUTPUT AND EFFICACY

LED Light Engine	Luminaire Light Output	Luminaire CBCP	Luminaire Efficacy (lms/watt)	System Wattage
800 Lumens 90 CRI	542*	1511*	60*	9
1000 Lumens 90 CRI	645	1799	62	10
1200 Lumens 90 CRI	793*	2213*	61*	13
1000 Lumens 80 CRI	671*	1871*	75*	9
1200 Lumens 80 CRI	800*	2231*	80*	10
1500 Lumens 80 CRI	987*	2752*	76*	13

*estimated values

PHOTOMETRIC REPORT with 36° internal lens and prismatic lens (PRS) (tested per IESNA LM-79-2008)

Prorated from Verification Services Report No. 12269958.06. Original test report furnished upon request.

Luminaire recessed LED square accent light with semi-specular clear aluminum reflector and prismatic lens, LED aimed at 15° above vertical.+
Light Source Cree CXB1310 LED with 36° beam spread integral lens, 2700K CCT, 90 CRI, 1000 lumens

CANDLEPOWER DISTRIBUTION (Candela)

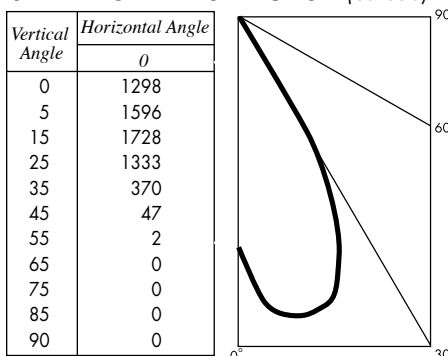

LUMINAIRE LIGHT OUTPUT AND EFFICACY

LED Light Engine	Luminaire Light Output	Luminaire CBCP	Luminaire Efficacy (lms/watt)	System Wattage
800 Lumens 90 CRI	538*	1457*	60*	9
1000 Lumens 90 CRI	640	1735	61	10
1200 Lumens 90 CRI	787*	2134*	61*	13
1000 Lumens 80 CRI	666*	1804*	74*	9
1200 Lumens 80 CRI	794*	2151*	79*	10
1500 Lumens 80 CRI	979*	2655*	75*	13

*estimated values