



MAGIC WAND® CLT O-OBM BLUETOOTH

surface mounted wireless multi-function accent light



Magic Wand CLT O-OBM Bluetooth
with Ring Baffle (OG)

Magic Wand CLT O-OBM Bluetooth
with Open Aperture (OH)



aperture view



aperture view

Magic Wand CLT O-OBM Bluetooth is an accent light designed for mounting on a 4" octagonal outlet box (by others). Fixture is powered by a Cree chip-on-board LED and is equipped with a Xicato intelligent driver (XID). See tables below for wattages and efficacies.

- Luminaire is equipped with a Xicato Bluetooth Low Energy Intelligent Driver, controllable via a smart device with iOS or Windows based apps. Features include
 - standard Bluetooth Wireless connectivity
 - addressable individually
 - on/off control
 - dimming to 0.1%
 - data collection and storage for operating history
 - direct listening to switches and sensors
 - embedded Eddystone, iBeacon and/or AltBeacon beacons
- Fixture function can be changed with your choice of Quick Change Cartridge – which can be removed from the fixture easily – and your choice of 'twist and lock' reflector.
- Quick Change Cartridge /Reflector choices
 - Quick Change Cartridge with a ring baffle (OG) for enhanced shielding; for use with a 10°, or 20° or 36° reflector
 - Quick Change Cartridge with an open aperture (OH) for maximum efficacy; for use with a 10°, 20° or 36° reflector
- Fixture is ordered with a single Quick Change Cartridge and a single reflector. Additional Quick Change Cartridges and reflectors may be ordered as accessories.
- **Optical Accessories:** Each Quick Change Cartridge accepts one of a number of spread lenses, color filters and screens. A complimentary Beam Smoother is included.
- **Concealed swivels** provide 350° of horizontal rotation and vertical adjustment from 0° to 90°. The swivels are permanently tensioned, allowing the fixture to remain fixed at any aiming angle.
- For more information, [click here](#).

PRODUCT CODE

For complete product code, list basic unit and select one item from each following box.

Basic Unit	MW-CLT-XID-OB
Quick Change Cartridge	
Ring Baffle	- OG
Open Aperture	- OH
Reflector	
10° narrow spot	- 10D
20° spot	- 20D
36° flood	- 36D
Light Source Output (Lumens)	
1200L / CRI 98	2700K & 3000K only - L12A
1500L / CRI 80+	- L15S
Light Color	
2700K	- 27K
3000K	- 30K
3500K	not available with all Light Outputs (see above) - 35K
4000K	not available with all Light Outputs (see above) - 40K
5000K	not available with all Light Outputs (see above) - 50K
Finish	
white: white paint, white lead cord, matte aluminum heat sink	- WH
black: black paint, black lead cord, black heat sink	- BL
Industrial Silver: silver paint, black lead cord, black heat sink	- SI
custom color: include physical chip with order and select one from below	
• white lead cord, matte aluminum heat sink	- CCW
• black lead cord, black heat sink	- CCB
• any other combination requires a special order	
Circuit Limitations	
Luminaire operates only on circuits with <u>no</u> dimmer on the circuit	

USB Key

To address this fixture from a Windows-based PC, laptop or tablet, a USB key (dongle) is required. Contact factory for USB key.

EXTRA REFLECTORS & CARTRIDGES

Specify as separate line items.

Reflector	
10° narrow spot	MW-CLT-10D
20° spot	MW-CLT-20D
36° flood	MW-CLT-36D
Quick Change Cartridge	
Open Aperture	MW-CLT-OH
Ring Baffle	MW-CLT-OG

OPTICAL ACCESSORIES ▼ See next page



OPTICAL ACCESSORIES

Specify as separate line items.

All are 2 3/8" (60mm) dia. Lenses and filters are glass; screens are aluminum.

diffuse glass	DGS/2.375
prismatic lens (Solite)	PLS/2.375
55° spread lens	LENS/2.375
40° x 70° spread lens	LENS/2.375-4070
beam smoother included with fixture	CLR/2.375
color filters	
Daylight Blue	DAY/2.375
Surprise Pink	PNK/2.375
amber	AMB/2.375
blue	BLU/2.375
green	GRN/2.375
red	RED/2.375
33% light reduction screen	SCR33/2.375
50% light reduction screen	SCR50/2.375

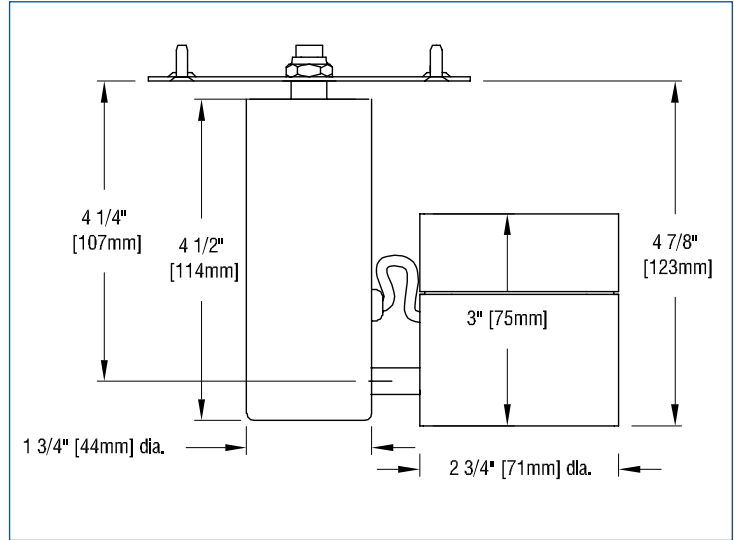

APPLICATIONS

Luminaire is suitable for highlighting vertical or horizontal surfaces, as well as objects in museums, galleries, showrooms, residences, offices and stores.

Luminaire is listed for Damp Location mounting on a standard 4" octagonal outlet box (by others).

STANDARD DRIVER INFORMATION (UL Class 2, dry and damp location)

Voltage	120	277
Input Watts (L12A/L15S)	14/14	14/14
Input Current (A) (L12A/L15S)	12/.12	.05/05
Output Current (mA)	350	350
Min. Power Factor	0.90	0.90
Operating Temperature Range (F)	-4 to 122	-4 to 122

LIGHT OUTPUT MULTIPLIER

(Based on 1500 lumens 80 CRI option)

LED Module Type	Light Output Multiplier
1200 Lumens 98 CRI (L12A)	0.76*
1500 Lumens 80 CRI (L15S)	1

*estimated values

– photometrics continued below –



PHOTOMETRIC REPORT with 10° reflector and OG Cartridge (tested per IESNA LM-79-2008)

UL Verification Services Report No. 12556986.01 Original test report furnished upon request.

Luminaire surface-mounted LED accent light with 10° reflector and black ring-baffle (no Lens)
 Lamp CREE LED 1500 lumens, 3000K CCT, 80 CRI
 Lamp Life rated 50.000 hours based on L70/B50 criteria. LM80 report by LED manufacturer furnished upon request

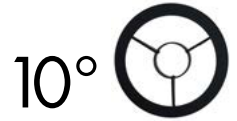

CANDLEPOWER DISTRIBUTION (Candela)

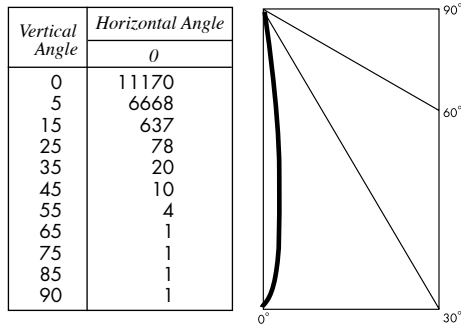

LUMINAIRE LIGHT OUTPUT AND EFFICACY

LED Module Type	Luminaire Light Output	Luminaire CBCP	Luminaire Efficacy (lms/watt)	System Wattage
1200 Lumens 98 CRI (L12A)	534*	8489*	38*	14
1500 Lumens 80 CRI (L15S)	702	11170	51	14

*estimated values

PHOTOMETRIC REPORT with 10° reflector and OH Cartridge (tested per IESNA LM-79-2008)

UL Verification Services Report No. 12556986.04 Original test report furnished upon request.

Luminaire surface-mounted LED accent light with 10° reflector and black lens holder (no Lens)
 Lamp CREE LED 1500 lumens, 3000K CCT
 Lamp Life rated 50.000 hours based on L70/B50 criteria. LM80 report by LED manufacturer furnished upon request

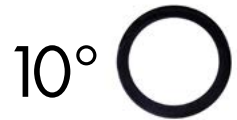

CANDLEPOWER DISTRIBUTION (Candela)

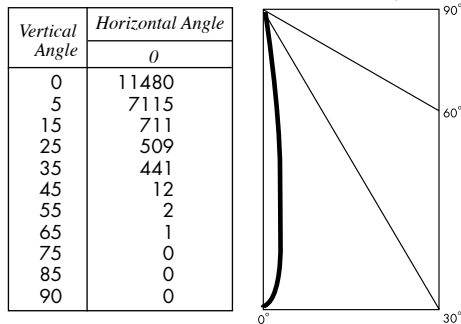

LUMINAIRE LIGHT OUTPUT AND EFFICACY

LED Module Type	Luminaire Light Output	Luminaire CBCP	Luminaire Efficacy (lms/watt)	System Wattage
1200 Lumens 98 CRI (L12A)	942*	8725*	67*	14
1500 Lumens 80 CRI (L15S)	1240	11480	90	14

*estimated values

PHOTOMETRIC REPORT with 20° reflector and OG Cartridge (tested per IESNA LM-79-2008)

UL Verification Services Report No. 12556986.02 Original test report furnished upon request.

Luminaire surface-mounted LED accent light with 20° reflector and black ring-baffle (no Lens)
 Lamp CREE LED 1500 lumens, 3000K CCT
 Lamp Life rated 50.000 hours based on L70/B50 criteria. LM80 report by LED manufacturer furnished upon request



CANDLEPOWER DISTRIBUTION (Candela)

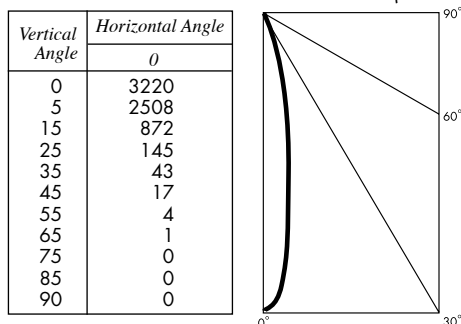

LUMINAIRE LIGHT OUTPUT AND EFFICACY

LED Module Type	Luminaire Light Output	Luminaire CBCP	Luminaire Efficacy (lms/watt)	System Wattage
1200 Lumens 98 CRI (L12A)	429*	2447*	31*	14
1500 Lumens 80 CRI (L15S)	565	3220	41	14

*estimated values

PHOTOMETRIC REPORT with 20° reflector and OH Cartridge (tested per IESNA LM-79-2008)

Verification Services Report No. 12556986.05 Original test report furnished upon request.

Luminaire surface-mounted LED accent light with 20° reflector and black lens holder (no Lens)
 Lamp CREE LED 1500 lumens, 3000K CCT
 Lamp Life rated 50.000 hours based on L70/B50 criteria. LM80 report by LED manufacturer furnished upon request



CANDLEPOWER DISTRIBUTION (Candela)

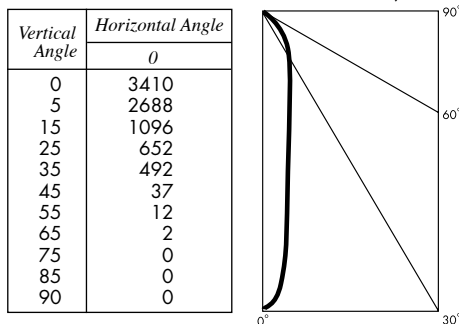

LUMINAIRE LIGHT OUTPUT AND EFFICACY

LED Module Type	Luminaire Light Output	Luminaire CBCP	Luminaire Efficacy (lms/watt)	System Wattage
1200 Lumens 98 CRI (L12A)	917*	2592*	66*	14
1500 Lumens 80 CRI (L15S)	1207	3410	88	14

*estimated values

PHOTOMETRIC REPORT with 36° reflector and OG Cartridge (tested per IESNA LM-79-2008)

Verification Services Report No. 12556986.03 Original test report furnished upon request.

Luminaire surface-mounted LED accent light with 36° reflector and black ring-baffle (no Lens)
 Lamp CREE LED 1500 lumens, 3000K CCT
 Lamp Life rated 50.000 hours based on L70/B50 criteria. LM80 report by LED manufacturer furnished upon request



CANDLEPOWER DISTRIBUTION (Candela)

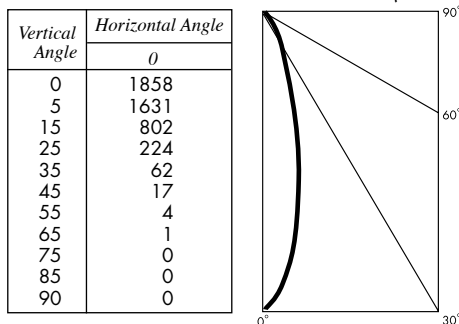

LUMINAIRE LIGHT OUTPUT AND EFFICACY

LED Module Type	Luminaire Light Output	Luminaire CBCP	Luminaire Efficacy (lms/watt)	System Wattage
1200 Lumens 98 CRI (L12A)	405*	1420*	29*	14
1500 Lumens 80 CRI (L15S)	533	1868	39	14

*estimated values

PHOTOMETRIC REPORT with 36° reflector and OH Cartridge (tested per IESNA LM-79-2008)

Verification Services Report No. 12556986.06 Original test report furnished upon request.

Luminaire surface-mounted LED accent light with 36° reflector and black lens holder (no Lens)
 Lamp CREE LED 1500 lumens, 3000K CCT
 Lamp Life rated 50.000 hours based on L70/B50 criteria. LM80 report by LED manufacturer furnished upon request



CANDLEPOWER DISTRIBUTION (Candela)

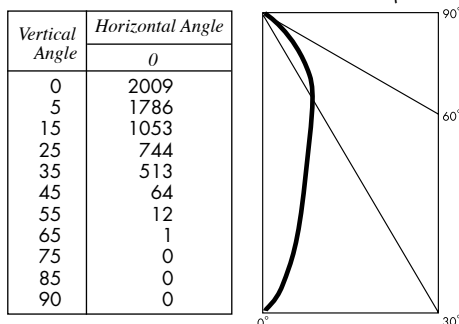

LUMINAIRE LIGHT OUTPUT AND EFFICACY

LED Module Type	Luminaire Light Output	Luminaire CBCP	Luminaire Efficacy (lms/watt)	System Wattage
1200 Lumens 98 CRI (L12A)	912*	1527*	65*	14
1500 Lumens 80 CRI (L15S)	1200	2009	87	14

*estimated values