



ARTIMA®/3 CZS O-OBM

surface mounted LED accent light



Artima/3 CZS O OBM
with Cross Baffle (OX)



aperture view



Artima/3 CZS O OBM
with Open Aperture (OH)



aperture view

Artima/3 CZS O-OBM is an accent light designed for mounting on a 4" octagonal outlet box. Luminaire is powered by one of a number of Citizen chip-on-board LED modules and is capable of 15°, 31°, 40° or 56° beam spreads. See tables below for wattages and efficacies.

- Fixture function can be changed with your choice of Quick Change Cartridge – which can be removed from the fixture easily – and your choice of 'twist and lock' reflector.
- Quick Change Cartridge / Reflector choices
 - Quick Change Cartridge with a cross baffle (OX) for enhanced glare control; for use with a 15°, 31°, 40° or 56° reflector.
 - Quick Change Cartridge with an open aperture (OH) for maximum efficacy; for use with a 15°, 31°, 40° or 56° reflector.
- Fixture is ordered with a single Quick Change Cartridge and a single reflector. Additional Quick Change Cartridges and reflectors may be ordered as accessories.
- Optical Accessories: Each Quick Change Cartridge accepts one or two of a number of spread lenses, color filters and screens. A complimentary high efficiency diffuser is included.
- Horizontal and vertical adjustment can be locked by tightening two collar clamps using a 3/32" hex key.
- For more information, [click here](#).

PRODUCT CODE

For complete product code, list basic unit and select one item from each following box.

Basic Unit	A3-CZS2-OB
Quick Change Cartridge	
Cross Baffle	- OX
Open Aperture	- OH
Reflector (specify one to ship with fixture)	
15° spot	- 15D
31° narrow flood.....	- 31D
40° flood.....	- 40D
56° wide flood.....	- 56D
Driver	
dimmable to 1% by a 0-10V dimmer on 120 or 277-volt service	- DMV
dimmable to 5% by either an incandescent or ELV dimmer; 120-volt service only	- DMP
dimmable to 1% by a Lutron (2-wire) incandescent dimmer	- DM1LU
dimmable to 1% by a Lutron EcoSystem control	- ECO-LU
eldoLED 0-10V (Logarithmic) driver dimmable to 0.1% with a 0-10V dimmer on 120 or 277-volt service.....	- DVOELG
eldoLED 0-10V (Linear) driver dimmable to 0.1% with a 0-10V dimmer on 120 or 277-volt service	- DVOELN
eldoLED driver dimmable to 0.1%, compatible with Dali control system	- DAO-EL
Moons' driver dimmable to 0.1% by DMX controllers	- DX0-MN
Light Source Output (Lumens)	
1500 lumens / 97 CRI	2700K & 3000K only..... - L15A
2100 lumens.....	2700K & 3000K only..... - L21A
2800 lumens.....	2700K & 3000K only..... - L28A
3000 lumens.....	2700K & 3000K only..... - L30A
1700 lumens / 90+ CRI.....	2700K & 3000K only..... - L17H
2300 lumens	2700K & 3000K only..... - L23H
3100 lumens.....	2700K & 3000K only..... - L31H
3400 lumens.....	2700K & 3000K only..... - L34H
1900 lumens / 80 CRI..... - L19S
2700 lumens..... - L27S
3600 lumens..... - L36S
4000 lumens..... - L40S
Light Color	
2700 K	- 27K
3000 K	- 30K
3500 K	not available in 90+CRI or 97 CRI (see above)..... - 35K
4000 K	not available in 90+CRI or 97 CRI (see above)..... - 40K
5000 K	not available in 90+CRI or 97 CRI (see above)..... - 50K
Finish	
white: white paint, white lead cord, matte aluminum heat sink	- WH
black: black paint, black lead cord, black heat sink	- BL
Industrial Silver: silver paint, black lead cord, black heat sink	- SI
custom color: include paint number or physical chip with order and select one from below	
• white lead cord, matte aluminum heat sink	- CCW
• black lead cord, black heat sink; black switch	- CCB
• any other combinations require a special order	

Light Color	
2700 K	- 27K
3000 K	- 30K
3500 K	not available in 90+CRI or 97 CRI (see above)..... - 35K
4000 K	not available in 90+CRI or 97 CRI (see above)..... - 40K
5000 K	not available in 90+CRI or 97 CRI (see above)..... - 50K

Finish	
white: white paint, white lead cord, matte aluminum heat sink	- WH
black: black paint, black lead cord, black heat sink	- BL
Industrial Silver: silver paint, black lead cord, black heat sink	- SI
custom color: include paint number or physical chip with order and select one from below	
• white lead cord, matte aluminum heat sink	- CCW
• black lead cord, black heat sink; black switch	- CCB
• any other combinations require a special order	

EXTRA REFLECTORS & CARTRIDGES

Specify as separate line items.

Reflector	
15° spot reflector.....	CZS2-REF-15D
31° narrow flood reflector	CZS2-REF-31D
40° flood reflector	CZS2-REF-40D
56° wide flood reflector	CZS2-REF-56D

Quick Change Cartridge	
Cross Baffle	- RK-A3+OX
Open Aperture	- RK-A3+OH

OPTICAL ACCESSORIES ▼ See next page



OPTICAL ACCESSORIES

Specify as separate line items.

All are 2 3/4" (70mm) dia. Lenses and filters are glass; screens are aluminum.

diffuse glass DGS/2.75

prismatic lens (Solite) PLS/2.75

55° spread lens LENS/2.75

40° x 70° spread lens LENS/2.75-4070

color filters

Daylight Blue DAY/2.75

Surprise Pink PNK/2.75

blue BLU/2.75

green GRN/2.75

red RED/2.75

33% light reduction screen SCR33/2.75

50% light reduction screen SCR50/2.75

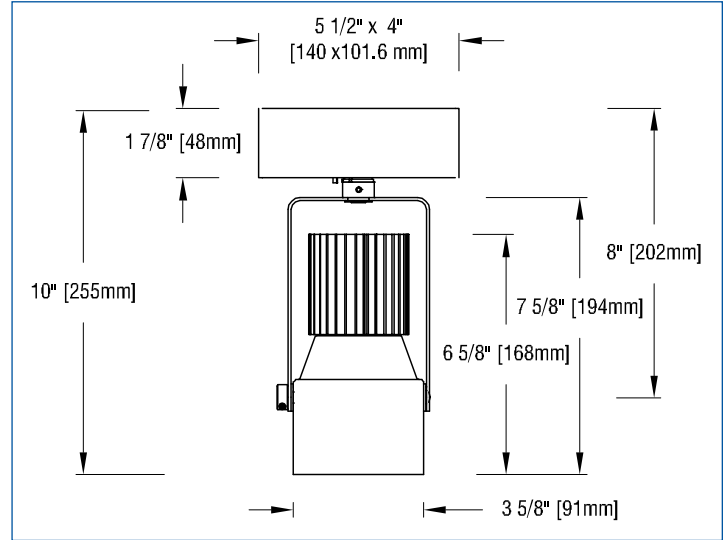

APPLICATIONS

Luminaire is suitable for highlighting vertical or horizontal surfaces, as well as objects in museums, galleries, showrooms, residences, offices and stores.

Luminaire is listed for Damp Location mounting on a standard 4" octagonal outlet box (by others).

STANDARD DRIVER INFORMATION (UL Class 2, dry and damp location)

Voltage	120	277
Input Watts (L15A/21A/28A/L30A/L17H/L23H/L31H/L34H/L19S/L27S/L36S/L40S lumens)	14/19/27/32	14/19/27/32
Input Current(A) (L15A/21A/28A/L30A/L17H/L23H/L31H/L34H/L19S/L27S/L36S/L40S lumens)	.12/.16/.23/.27	.05/.07/.10/.12
Output Current (mA)	350-800	350-800
Min. Power Factor	0.90	0.90
Operating Temperature Range (F)	-13 to 122	-13 to 122

LIGHT OUTPUT MULTIPLIER

LED Module Type	Light Output Multiplier
1500 Lumens 97 CRI (L15A)	0.37*
2100 Lumens 97 CRI (L21A)	0.51*
2800 Lumens 97 CRI (L28A)	0.69*
3000 Lumens 97 CRI (L30A)	0.77*
1700 Lumens 90 CRI (L17H)	0.42*
2300 Lumens 90 CRI (L23H)	0.58*
3100 Lumens 90 CRI (L31H)	0.77*
3400 Lumens 90CRI (L34H)	0.86*
1900 Lumens 80 CRI (L19S)	0.49*
2700 Lumens 80 CRI (L27S)	0.68*
3600 Lumens 80 CRI (L36S)	0.91*
4000 Lumens 80 CRI (L40S)	1

*estimated values

LED CCT MULTIPLIERS

2700K	.96
3000K	1
3500K	1.02
4000K	1.03
5000K	1.04

– photometrics continued below –



PHOTOMETRIC REPORT with 15° reflector (tested per IESNA LM-79-2008)



UL Verification Services Report No. 12713115.05A. Original test report furnished upon request.

Luminaire surface-mounted LED accent light with a 15° reflector and black cross-baffle (NO LENS)
 Lamp Citizen LED Module, 4000 lumens, 3000K
 Lamp Life rated 50.000 hours based on L70/B50 criteria. LM80 report by LED manufacturer furnished upon request

CANDLEPOWER DISTRIBUTION (Candela)

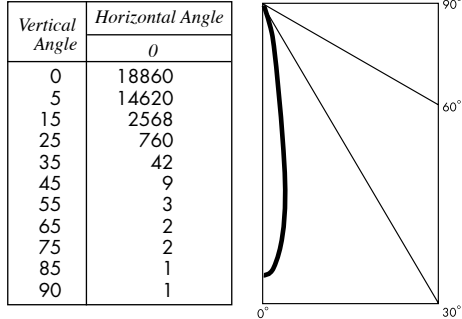

LUMINAIRE LIGHT OUTPUT AND EFFICACY

LED Module Type	Luminaire Light Output	Luminaire CBCP	Luminaire Efficacy (lms/watt)	System Wattage
1500 Lumens 97 CRI (L15A)	828*	6977*	59*	14
2100 Lumens 97 CRI (L21A)	1141*	9617*	60*	19
2800 Lumens 97 CRI (L28A)	1544*	13011*	57*	27
3000 Lumens 97 CRI (L30A)	1722*	14520*	54*	32
1700 Lumens 90 CRI (L17H)	940*	7920*	67*	14
2300 Lumens 90 CRI (L23H)	1297*	10937*	68*	19
3100 Lumens 90 CRI (L31H)	1722*	14520*	64*	27
3400 Lumens 90CRI (L34H)	1924*	16217*	60*	32
1900 Lumens 80 CRI (L19S)	1096*	9240*	78*	14
2700 Lumens 80 CRI (L27S)	1521*	12823*	80*	19
3600 Lumens 80 CRI (L36S)	2036*	17160*	75*	27
4000 Lumens 80 CRI (L40S)	2237	18857	69	32

*estimated values

PHOTOMETRIC REPORT with 15° reflector (tested per IESNA LM-79-2008)



UL Verification Services Report No. 12713115.01A. Original test report furnished upon request.

Luminaire surface-mounted LED accent light with a 15° reflector and open aperture (NO LENS)
 Lamp Citizen LED Module, 4000 lumens, 3000K
 Lamp Life see above

CANDLEPOWER DISTRIBUTION (Candela)

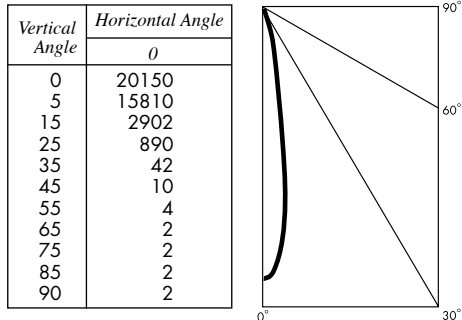

LUMINAIRE LIGHT OUTPUT AND EFFICACY

LED Module Type	Luminaire Light Output	Luminaire CBCP	Luminaire Efficacy (lms/watt)	System Wattage
1500 Lumens 97 CRI (L15A)	898*	7456*	64*	14
2100 Lumens 97 CRI (L21A)	1237*	10277*	65*	19
2800 Lumens 97 CRI (L28A)	1674*	13904*	62*	27
3000 Lumens 97 CRI (L30A)	1868*	15516*	58*	32
1700 Lumens 90 CRI (L17H)	1019*	8463*	73*	14
2300 Lumens 90 CRI (L23H)	1407*	11687*	74*	19
3100 Lumens 90 CRI (L31H)	1868*	15516*	69*	27
3400 Lumens 90CRI (L34H)	2086*	17329*	65*	32
1900 Lumens 80 CRI (L19S)	1189*	9874*	85*	14
2700 Lumens 80 CRI (L27S)	1650*	13702*	87*	19
3600 Lumens 80 CRI (L36S)	2208*	18337*	82*	27
4000 Lumens 80 CRI (L40S)	2426	20150	76	32

*estimated values

PHOTOMETRIC REPORT with 31° reflector (tested per IESNA LM-79-2008)



UL Verification Services Report No. 12713115.06A. Original test report furnished upon request.

Luminaire surface-mounted LED accent light with a 31° reflector and black cross-baffle (NO LENS)
 Lamp Citizen LED Module, 4000 lumens, 3000K
 Lamp Life see above

CANDLEPOWER DISTRIBUTION (Candela)

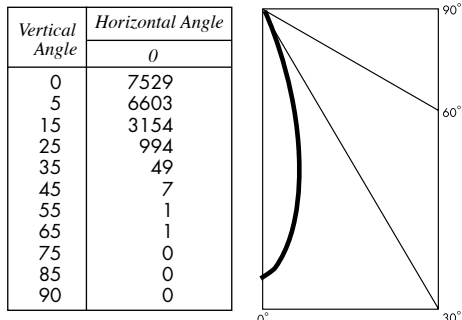

LUMINAIRE LIGHT OUTPUT AND EFFICACY

LED Module Type	Luminaire Light Output	Luminaire CBCP	Luminaire Efficacy (lms/watt)	System Wattage
1500 Lumens 97 CRI (L15A)	707*	2794*	50*	14
2100 Lumens 97 CRI (L21A)	974*	3851*	51*	19
2800 Lumens 97 CRI (L28A)	1318*	5210*	49*	27
3000 Lumens 97 CRI (L30A)	1471*	5814*	46*	32
1700 Lumens 90 CRI (L17H)	802*	3171*	57*	14
2300 Lumens 90 CRI (L23H)	1108*	4379*	58*	19
3100 Lumens 90 CRI (L31H)	1471*	5814*	54*	27
3400 Lumens 90CRI (L34H)	1643*	6493*	51*	32
1900 Lumens 80 CRI (L19S)	936*	3700*	67*	14
2700 Lumens 80 CRI (L27S)	1299*	5134*	68*	19
3600 Lumens 80 CRI (L36S)	1738*	6871*	64*	27
4000 Lumens 80 CRI (L40S)	1910	7550	59	32

*estimated values

PHOTOMETRIC REPORT with 31° reflector (tested per IESNA LM-79-2008)



UL Verification Services Report No. 12713115.02A. Original test report furnished upon request.

Luminaire surface-mounted LED accent light with a 31° reflector and open aperture (NO LENS)
 Lamp Citizen LED Module, 4000 lumens, 3000K
 Lamp Life rated 50.000 hours based on L70/B50 criteria. LM80 report by LED manufacturer furnished upon request

CANDLEPOWER DISTRIBUTION (Candela)

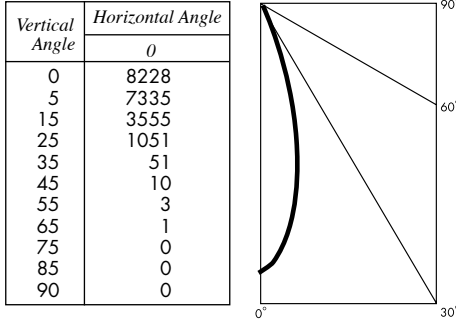

LUMINAIRE LIGHT OUTPUT AND EFFICACY

LED Module Type	Luminaire Light Output	Luminaire CBCP	Luminaire Efficacy (lms/watt)	System Wattage
1500 Lumens 97 CRI (L15A)	785*	3044*	56*	14
2100 Lumens 97 CRI (L21A)	1082*	4196*	57*	19
2800 Lumens 97 CRI (L28A)	1463*	5677*	54*	27
3000 Lumens 97 CRI (L30A)	1633*	6336*	51*	32
1700 Lumens 90 CRI (L17H)	891*	3456*	64*	14
2300 Lumens 90 CRI (L23H)	1230*	4772*	65*	19
3100 Lumens 90 CRI (L31H)	1633*	6336*	60*	27
3400 Lumens 90CRI (L34H)	1824*	7076*	57*	32
1900 Lumens 80 CRI (L19S)	1039*	4032*	74*	14
2700 Lumens 80 CRI (L27S)	1442*	5595*	76*	19
3600 Lumens 80 CRI (L36S)	1930*	7487*	71*	27
4000 Lumens 80 CRI (L40S)	2121	8228	66	32

*estimated values

PHOTOMETRIC REPORT with 40° reflector (tested per IESNA LM-79-2008)



UL Verification Services Report No. 12713115.07A. Original test report furnished upon request.

Luminaire surface-mounted LED accent light with a 40° reflector and black cross-baffle (NO LENS)
 Lamp Citizen LED Module, 4000 lumens, 3000K
 Lamp Life see above

CANDLEPOWER DISTRIBUTION (Candela)

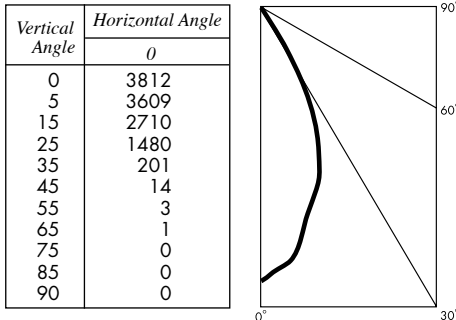

LUMINAIRE LIGHT OUTPUT AND EFFICACY

LED Module Type	Luminaire Light Output	Luminaire CBCP	Luminaire Efficacy (lms/watt)	System Wattage
1500 Lumens 97 CRI (L15A)	705	1410	50	14
2100 Lumens 97 CRI (L21A)	972	1944	51	19
2800 Lumens 97 CRI (L28A)	1314	2630	49	27
3000 Lumens 97 CRI (L30A)	1467	2935	46	32
1700 Lumens 90 CRI (L17H)	800	1601	57	14
2300 Lumens 90 CRI (L23H)	1105	2211	58	19
3100 Lumens 90 CRI (L31H)	1467	2935	54	27
3400 Lumens 90CRI (L34H)	1638	3278	51	32
1900 Lumens 80 CRI (L19S)	933	1868	67	14
2700 Lumens 80 CRI (L27S)	1295	2592	68	19
3600 Lumens 80 CRI (L36S)	1734	3469	64	27
4000 Lumens 80 CRI (L40S)	1905	3812	59	32

*estimated values

PHOTOMETRIC REPORT with 40° reflector (tested per IESNA LM-79-2008)



UL Verification Services Report No. 12713115.03A. Original test report furnished upon request.

Luminaire surface-mounted LED accent light with a 40° reflector and open aperture (NO LENS)
 Lamp Citizen LED Module, 4000 lumens, 3000K
 Lamp Life see above

CANDLEPOWER DISTRIBUTION (Candela)

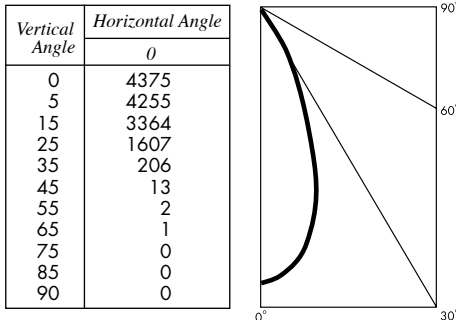

LUMINAIRE LIGHT OUTPUT AND EFFICACY

LED Module Type	Luminaire Light Output	Luminaire CBCP	Luminaire Efficacy (lms/watt)	System Wattage
1500 Lumens 97 CRI (L15A)	810*	1619*	58*	14
2100 Lumens 97 CRI (L21A)	1117*	2231*	59*	19
2800 Lumens 97 CRI (L28A)	1511*	3019	56*	27
3000 Lumens 97 CRI (L30A)	1686*	3369*	53*	32
1700 Lumens 90 CRI (L17H)	920*	1838*	66*	14
2300 Lumens 90 CRI (L23H)	1270*	2538*	67*	19
3100 Lumens 90 CRI (L31H)	1686*	3369*	62*	27
3400 Lumens 90CRI (L34H)	1883*	3763*	59*	32
1900 Lumens 80 CRI (L19S)	1073*	2144*	77*	14
2700 Lumens 80 CRI (L27S)	1489*	2975*	78*	19
3600 Lumens 80 CRI (L36S)	1993*	3981*	74*	27
4000 Lumens 80 CRI (L40S)	2190	4375	67	32

*estimated values

PHOTOMETRIC REPORT with 56° reflector (tested per IESNA LM-79-2008)

Ⓛ Verification Services Report No. 12713115.08A. Original test report furnished upon request.

Luminaire surface-mounted LED accent light with a 56° reflector and black cross-baffle (NO LENS)

Lamp Citizen LED Module, 4000 lumens, 3000K

Lamp Life rated 50.000 hours based on L70/B50 criteria. LM80 report by LED manufacturer furnished upon request



CANDLEPOWER DISTRIBUTION (Candela)

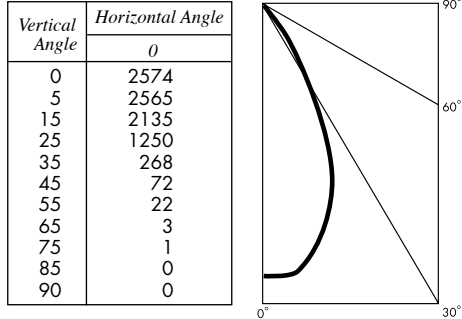

LUMINAIRE LIGHT OUTPUT AND EFFICACY

LED Module Type	Luminaire Light Output	Luminaire CBCP	Luminaire Efficacy (lms/watt)	System Wattage
1500 Lumens 97 CRI (L15A)	621*	955*	44*	14
2100 Lumens 97 CRI (L21A)	856*	1316*	45*	19
2800 Lumens 97 CRI (L28A)	1159*	1780*	43*	27
3000 Lumens 97 CRI (L30A)	1293*	1987*	40*	32
1700 Lumens 90 CRI (L17H)	705*	1084*	50*	14
2300 Lumens 90 CRI (L23H)	974*	1496*	51*	19
3100 Lumens 90 CRI (L31H)	1293*	1987*	48*	27
3400 Lumens 90CRI (L34H)	1444*	2219*	45*	32
1900 Lumens 80 CRI (L19S)	823*	1264*	59*	14
2700 Lumens 80 CRI (L27S)	1142*	1754*	60*	19
3600 Lumens 80 CRI (L36S)	1528*	2348*	57*	27
4000 Lumens 80 CRI (L40S)	1679	2580	52	32

*estimated values

PHOTOMETRIC REPORT with 56° reflector (tested per IESNA LM-79-2008)

Ⓛ Verification Services Report No. 12713115.04A. Original test report furnished upon request.

Luminaire surface-mounted LED accent light with a 56° reflector and open aperture (NO LENS)

Lamp Citizen LED Module, 4000 lumens, 3000K

Lamp Life see above

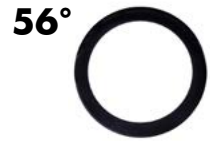

CANDLEPOWER DISTRIBUTION (Candela)

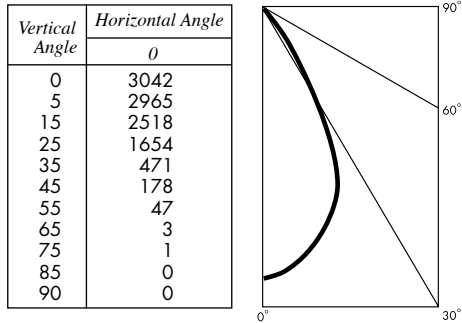

LUMINAIRE LIGHT OUTPUT AND EFFICACY

LED Module Type	Luminaire Light Output	Luminaire CBCP	Luminaire Efficacy (lms/watt)	System Wattage
1500 Lumens 97 CRI (L15A)	808*	1126*	58*	14
2100 Lumens 97 CRI (L21A)	1114*	1551*	59*	19
2800 Lumens 97 CRI (L28A)	1508*	2099*	56*	27
3000 Lumens 97 CRI (L30A)	1682*	2342*	53*	32
1700 Lumens 90 CRI (L17H)	918*	1278*	66*	14
2300 Lumens 90 CRI (L23H)	1267*	1764*	67*	19
3100 Lumens 90 CRI (L31H)	1682*	2342*	62*	27
3400 Lumens 90CRI (L34H)	1879*	2616*	59*	32
1900 Lumens 80 CRI (L19S)	1071*	1491*	76*	14
2700 Lumens 80 CRI (L27S)	1486*	2069*	78*	19
3600 Lumens 80 CRI (L36S)	1988*	2768*	74*	27
4000 Lumens 80 CRI (L40S)	2185	3042	67	32

*estimated values