

MAGIC WAND® CLT O

track mounted multi-function accent light



Magic Wand CLT O is a track mounted accent light powered by one of a number of Cree chip-on-board LED's. See tables below for wattages and efficacies.

- Fixtures may be configured to mount to any of eighteen 20-amp, 12-volt [track systems](#) – or – to any of six 277-volt track systems.
- Fixture function can be changed with your choice of Quick Change Cartridge – which can be removed from the fixture easily – and your choice of 'twist and lock' [reflector](#).
- Quick Change Cartridge / Reflector choices
 - Quick Change Cartridge with a ring baffle (OG) for enhanced shielding; for use with a 10°, or 20° or 36° reflector
 - Quick Change Cartridge with an open aperture (OH) for maximum efficacy; for use with a 10°, 20° or 36° reflector
- Fixture is provided with a single Quick Change Cartridge and a single reflector. Additional Quick Change Cartridges and reflectors may be ordered as accessories.
- [Optical Accessories](#): Each Quick Change Cartridge accepts one of a number of spread lenses, color filters and screens. A complimentary Beam Smoother is included.
- [Concealed swivels](#) provide 350° of horizontal rotation and vertical adjustment from 0° to 90°. The swivels are permanently tensioned, allowing the fixture to remain fixed at any aiming angle.
- For more information, [click here](#).

PRODUCT CODE

For complete product code, list basic unit and select one item from each following box.

| | |
|---|-------------------------------------|
| Basic Unit | MW-CLT |
| Track Configuration | |
| 120-volt track (e.g. SightLine) | 2C |
| 277-volt track (e.g. HighLine) | no switch option; not dimmable - HC |
| Quick Change Cartridge | |
| Ring Baffle | OG |
| Open Aperture | OH |
| Reflector | |
| 10° narrow spot | 10D |
| 20° spot | 20D |
| 36° flood | 36D |
| Driver (DMP): Fixture includes a driver which is | |
| • dimmable to 10% with an incandescent or electronic low voltage (ELV) dimming on 120-volt track (2C) – and – | |
| • not dimmable at all on 277-volt track (HC). | |
| For a model that dims wirelessly, see Magic Wand CLT O-Bluetooth | |

| | |
|-------------------------------------|--|
| Light Source Output (Lumens) | |
| 800L / CRI 98 | not available for 277v ... 5000K not available..... - L08A |
| 1200L | 5000K not available - L12A |
| 1100L / CRI 80+ | not available for 277v - L11S |
| 1500L | - L15S |

| | |
|--------------------|---|
| Light Color | |
| 2700K | 27K |
| 3000K | 30K |
| 3500K | 35K |
| 4000K | 40K |
| 5000K | not available with all Light Outputs (see above)..... - 50K |

| | |
|--|------|
| Finish | |
| white: white paint, white lead cord, matte aluminum heat sink | - WH |
| black: black paint, black lead cord, black heat sink | - BL |
| Industrial Silver: silver paint, black lead cord, black heat sink | - SI |
| custom color: include paint number or physical chip with order and select one from below | |
| • white lead cord, matte aluminum heat sink, white switch (if any)..... - CCW | |
| • black lead cord, black heat sink, black switch (if any) | |
| • any other combination requires a special order | |

OPTIONS *Specify by adding to the product code.*

| | |
|--|------|
| rocker type on/off switch in track adapter; for use on 120-volt track only; track adapter lengthened to 7 5/8" | - SW |
| <i>white switch for white fixture; black for Silver or black fixture; white or black switch for custom color fixture, see Finish box above</i> | |

EXTRA REFLECTORS & CARTRIDGES

Specify as separate line items.

| | |
|-----------------------|------------|
| Reflector | |
| 10° narrow spot | MW-CLT-10D |
| 20° spot | MW-CLT-20D |
| 36° flood | MW-CLT-36D |

| | |
|-------------------------------|-----------|
| Quick Change Cartridge | |
| Open Aperture | MW-CLT-OH |
| Ring Baffle | MW-CLT-OG |

OPTICAL ACCESSORIES ▼ *See next page*

OPTICAL ACCESSORIES

Specify as separate line items.

All are 2 3/8" (60mm) dia. Lenses and filters are glass; screens are aluminum.

| | |
|--|-----------------|
| diffuse glass | DGS/2.375 |
| prismatic lens (Solite) | PLS/2.375 |
| 55° spread lens | LENS/2.375 |
| 40° x 70° spread lens | LENS/2.375-4070 |
| beam smoother included with fixture | CLR/2.375 |
| color filters | |
| Daylight Blue | DAY/2.375 |
| Surprise Pink | PNK/2.375 |
| amber | AMB/2.375 |
| blue | BLU/2.375 |
| green | GRN/2.375 |
| red | RED/2.375 |
| 33% light reduction screen | SCR33/2.375 |
| 50% light reduction screen | SCR50/2.375 |

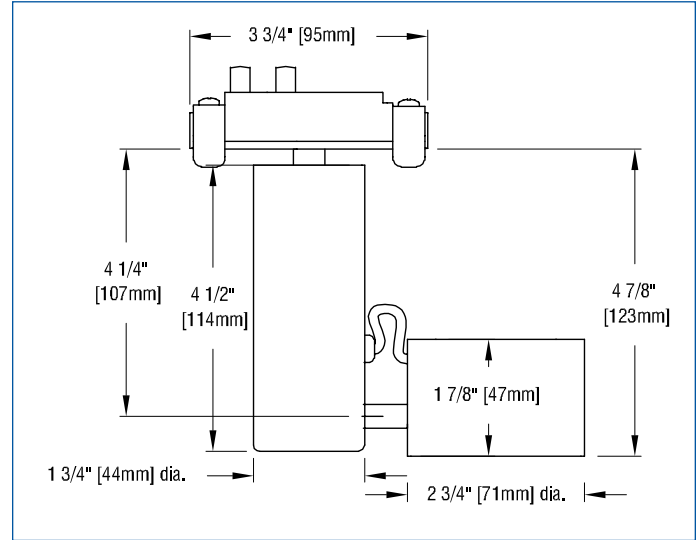

APPLICATIONS

Luminaire is suitable for highlighting vertical or horizontal surfaces, as well as objects in museums, galleries, showrooms, residences, offices and stores.

Luminaire is listed for mounting on Edison Price Lighting 120-volt or 277-volt track.

STANDARD DRIVER INFORMATION (UL Class 2, dry and damp location)

| Voltage | 120 | 277 |
|---|--------------|--------------|
| Input Watts (L08A/L12A/L11S/L15S) | 9/14/9/14 | 9/14/9/14 |
| Input Current(A) (L08A/L12A/L11S/L15S) | .08/12/08/12 | .03/05/03/05 |
| Output Current (mA) | 250-350 | 250-350 |
| Min. Power Factor | 0.90 | 0.90 |
| Operating Temperature Range (F) | -4 to 122 | -4 to 122 |

LIGHT OUTPUT MULTIPLIER

(Based on 1500 lumens 80 CRI option)

| LED Module Type | Light Output Multiplier |
|---------------------------|-------------------------|
| 800 Lumens 98 CRI (L08A) | 0.52* |
| 1200 Lumens 98 CRI (L12A) | 0.76* |
| 1100 Lumens 80 CRI (L11S) | 0.69* |
| 1500 Lumens 80 CRI (L15S) | 1 |

*estimated values

– photometrics continued below –



PHOTOMETRIC REPORT with 10° reflector and OG Cartridge (tested per IESNA LM-79-2008)

Verification Services Report No. 12556986.01 Original test report furnished upon request.

Luminaire track-mounted LED accent light with 10° reflector and black ring-baffle (no Lens)
 Lamp CREE LED 1500 lumens, 3000K CCT, 80 CRI
 Lamp Life rated 50.000 hours based on L70/B50 criteria. LM80 report by LED manufacturer furnished upon request

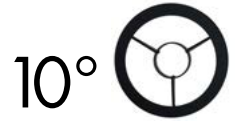

CANDLEPOWER DISTRIBUTION

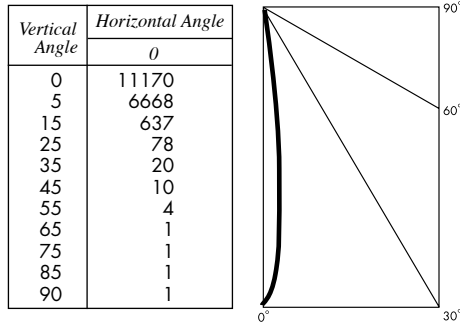

LUMINAIRE LIGHT OUTPUT AND EFFICACY

| LED Module Type | Luminaire Light Output | Luminaire CBCP | Luminaire Efficacy (lms/watt) | System Wattage |
|---------------------------|------------------------|----------------|-------------------------------|----------------|
| 800 Lumens 98 CRI (L08A) | 365* | 5808* | 41* | 9 |
| 1200 Lumens 98 CRI (L12A) | 534* | 8489* | 38* | 14 |
| 1100 Lumens 80 CRI (L11S) | 484* | 7707* | 54* | 9 |
| 1500 Lumens 80 CRI (L15S) | 702 | 11170 | 51 | 14 |

*estimated values

PHOTOMETRIC REPORT with 10° reflector and OH Cartridge (tested per IESNA LM-79-2008)

Verification Services Report No. 12556986.04 Original test report furnished upon request.

Luminaire track-mounted LED accent light with 10° reflector and black lens holder (no Lens)
 Lamp CREE LED 1500 lumens, 3000K CCT
 Lamp Life rated 50.000 hours based on L70/B50 criteria. LM80 report by LED manufacturer furnished upon request

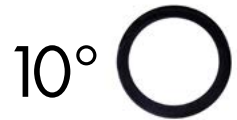

CANDLEPOWER DISTRIBUTION

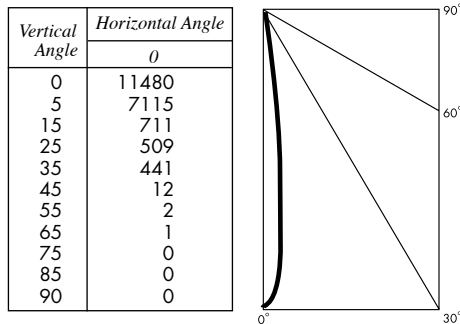

LUMINAIRE LIGHT OUTPUT AND EFFICACY

| LED Module Type | Luminaire Light Output | Luminaire CBCP | Luminaire Efficacy (lms/watt) | System Wattage |
|---------------------------|------------------------|----------------|-------------------------------|----------------|
| 800 Lumens 98 CRI (L08A) | 645* | 5970* | 72* | 9 |
| 1200 Lumens 98 CRI (L12A) | 942* | 8725* | 67* | 14 |
| 1100 Lumens 80 CRI (L11S) | 856* | 7921* | 95* | 9 |
| 1500 Lumens 80 CRI (L15S) | 1240 | 11480 | 90 | 14 |

*estimated values

PHOTOMETRIC REPORT with 20° reflector and OG Cartridge (tested per IESNA LM-79-2008)

Verification Services Report No. 12556986.02 Original test report furnished upon request.

Luminaire track-mounted LED accent light with 20° reflector and black ring-baffle (no Lens)
 Lamp CREE LED 1500 lumens, 3000K CCT
 Lamp Life rated 50.000 hours based on L70/B50 criteria. LM80 report by LED manufacturer furnished upon request



CANDLEPOWER DISTRIBUTION

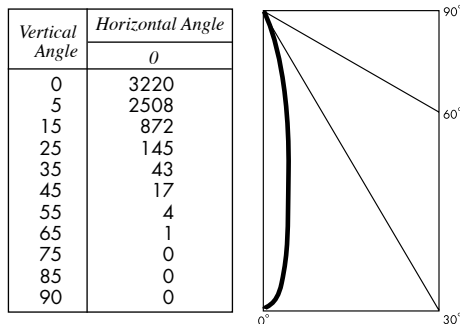

LUMINAIRE LIGHT OUTPUT AND EFFICACY

| LED Module Type | Luminaire Light Output | Luminaire CBCP | Luminaire Efficacy (lms/watt) | System Wattage |
|---------------------------|------------------------|----------------|-------------------------------|----------------|
| 800 Lumens 98 CRI (L08A) | 294* | 1674* | 33* | 9 |
| 1200 Lumens 98 CRI (L12A) | 429* | 2447* | 31* | 14 |
| 1100 Lumens 80 CRI (L11S) | 390* | 2222* | 43* | 9 |
| 1500 Lumens 80 CRI (L15S) | 565 | 3220 | 41 | 14 |

*estimated values

PHOTOMETRIC REPORT with 20° reflector and OH Cartridge (tested per IESNA LM-79-2008)

Verification Services Report No. 12556986.05 Original test report furnished upon request.

Luminaire track-mounted LED accent light with 20° reflector and black lens holder (no Lens)

Lamp CREE LED 1500 lumens, 3000K CCT

Lamp Life rated 50.000 hours based on L70/B50 criteria. LM80 report by LED manufacturer furnished upon request



CANDLEPOWER DISTRIBUTION

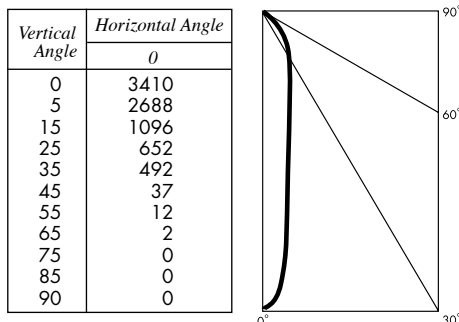

LUMINAIRE LIGHT OUTPUT AND EFFICACY

| LED Module Type | Luminaire Light Output | Luminaire CBCP | Luminaire Efficacy (lms/watt) | System Wattage |
|---------------------------|------------------------|----------------|-------------------------------|----------------|
| 800 Lumens 98 CRI (L08A) | 628* | 1773* | 70* | 9 |
| 1200 Lumens 98 CRI (L12A) | 917* | 2592* | 66* | 14 |
| 1100 Lumens 80 CRI (L11S) | 833* | 2353* | 93* | 9 |
| 1500 Lumens 80 CRI (L15S) | 1207 | 3410 | 88 | 14 |

*estimated values

PHOTOMETRIC REPORT with 36° reflector and OG Cartridge (tested per IESNA LM-79-2008)

Verification Services Report No. 12556986.03 Original test report furnished upon request.

Luminaire track-mounted LED accent light with 36° reflector and black ring-baffle (no Lens)

Lamp CREE LED 1500 lumens, 3000K CCT

Lamp Life rated 50.000 hours based on L70/B50 criteria. LM80 report by LED manufacturer furnished upon request



CANDLEPOWER DISTRIBUTION

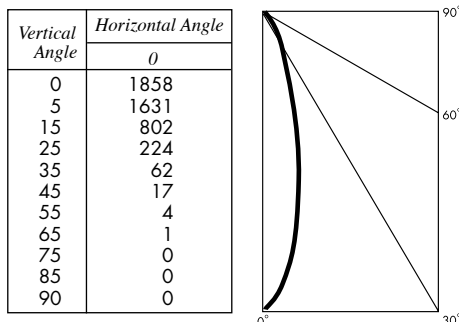

LUMINAIRE LIGHT OUTPUT AND EFFICACY

| LED Module Type | Luminaire Light Output | Luminaire CBCP | Luminaire Efficacy (lms/watt) | System Wattage |
|---------------------------|------------------------|----------------|-------------------------------|----------------|
| 800 Lumens 98 CRI (L08A) | 277* | 971* | 31* | 9 |
| 1200 Lumens 98 CRI (L12A) | 405* | 1420* | 29* | 14 |
| 1100 Lumens 80 CRI (L11S) | 368* | 1289* | 41* | 9 |
| 1500 Lumens 80 CRI (L15S) | 533 | 1868 | 39 | 14 |

*estimated values

PHOTOMETRIC REPORT with 36° reflector and OH Cartridge (tested per IESNA LM-79-2008)

Verification Services Report No. 12556986.06 Original test report furnished upon request.

Luminaire track-mounted LED accent light with 36° reflector and black lens holder (no Lens)

Lamp CREE LED 1500 lumens, 3000K CCT

Lamp Life rated 50.000 hours based on L70/B50 criteria. LM80 report by LED manufacturer furnished upon request



CANDLEPOWER DISTRIBUTION

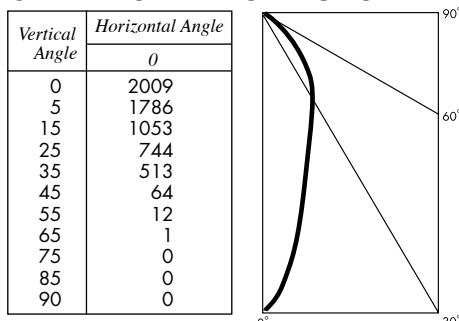

LUMINAIRE LIGHT OUTPUT AND EFFICACY

| LED Module Type | Luminaire Light Output | Luminaire CBCP | Luminaire Efficacy (lms/watt) | System Wattage |
|---------------------------|------------------------|----------------|-------------------------------|----------------|
| 800 Lumens 98 CRI (L08A) | 624* | 1045* | 69* | 9 |
| 1200 Lumens 98 CRI (L12A) | 912* | 1527* | 65* | 14 |
| 1100 Lumens 80 CRI (L11S) | 828* | 1386* | 92* | 9 |
| 1500 Lumens 80 CRI (L15S) | 1200 | 2009 | 87 | 14 |

*estimated values