

Project

Date

Product Code

Type

Designer



IDM MIDIMAX™ O

track mounted LED accent light with integral dimmer



IDM MidiMax O Bluetooth is a track mounted accent light capable of 20°, 40° or 60° beam spreads. Luminaire is powered by one of a number of Xicato LED modules, all of which are distinguished by extraordinary color consistency (within a 1x2-step MacAdam ellipse). See tables below for wattages and efficacies.

- Luminaire may be configured to mount to any of eighteen 20-amp, 120-volt track systems – or – to any of six 277-volt track systems.
- Whether operated on 120-volt or 277-volt track, luminaire may be dimmed to 10% by an integral rotary dimmer located in the center of the housing top. Dimmer control shaft is spring loaded, permitting shaft to be expressed for adjustment and then depressed flush with the housing top to conserve dimmer setting. ‘Clock face’ markings permit registration of dimmer setting. (See illustrations below.)
- Fixture function can be changed with your choice of Aperture Assembly and your choice of ‘twist and lock’ reflector.
- Bluetooth controls and integral rotary dimmer can be specified together in the same fixture. Users can dim by the protocol of their choice, switching between the two options as desired.
- Aperture Assembly / Reflector choices
 - Cross Baffle (OX) for enhanced glare control ; for use with interchangeable 20°, 40° and 60° reflectors.
 - Open Aperture (OH) for maximum efficacy; for use with interchangeable 20°, 40° and 60° reflectors.
 Fixture is ordered with a single Aperture Assembly and a single reflector. Additional aperture assemblies and reflectors may be ordered as accessories.
- Optical Accessories: Both OX and OH Aperture Assemblies accept one or two of a number of spread lenses or color filters. With the OX assembly lens orientation may be adjusted by rotating the cross baffle. A complimentary beam smoother is included with either assembly.
- A concealed swivel provides 385° horizontal rotation and vertical adjustment from 0° to 90°. The swivel is permanently tensioned, allowing the luminaire to remain fixed at any aiming angle.
- MidiMax luminaires have seamless aluminum housings and cast aluminum tops for lightweight durability and heat dissipation.
- For more information, [click here](#).

For the outlet box mounted version of this luminaire, see [IDM MidiMax O-OBM](#).

PRODUCT CODE

For complete product code, list basic unit and select one item from each following box.

Basic Unit	IDM-LX2-XTM
Track Configuration	
120-volt track (e.g. SightLine)	- 2C
277-volt track (e.g. HighLine)	switch not available - HC
Aperture Assembly	
Cross Baffle	- OX
Open Aperture	- OH
Beam Spread Reflector (specify one to ship with fixture)	
20° spot	- 20D
40° flood	- 40D
60° wide flood	- 60D
Finish	
white paint finish	- WH
black paint finish	- BL
Industrial Silver paint finish	- SI
custom color paint finish... include paint number or physical chip with order ..	- CC
Light Source Output	
2100 lumens / CRI 98 Artist	- L21A
2100 lumens / CRI 80+	- L21S
2100 lumens / CRI 80+ Vibrant3000K only.....	- L21V
2700 lumens / CRI 80+	- L27S
2700 lumens / CRI 80+ Vibrant3000K only.....	- L27V
Light Color	
2700 K	- 27K
3000 K	- 30K
3500 K	- 35K
4000 K	- 40K

- Dimming Notes:**
- Fixture may be dimmed only by its integral dimmer.
 - Fixture cannot be dimmed by a dimmer of any kind on the track circuit.
 - Fixture may be damaged by use of an incandescent or ELV dimmer on the track circuit.
 - Fixture will not be dimmed or damaged by use of a 0-10V dimmer on the track circuit.
 - Combination with wireless Bluetooth controls available on [Bluetooth](#) model.

OPTIONS *Specify by adding to the product code.*

a rocker type **on/off switch** on fixture top, for use on 120-volt track only..... - SW
 white switch for white fixture, black for Silver or black fixture, specify which for custom color fixture

EXTRA APERTURES & REFLECTORS

Specify as separate line items.

Aperture Assembly	
Cross Baffle	RK-LX-OX
Open Aperture	RK-LX-OH
Reflector	
20° spot	RK-LX-XTM-REF-D20
40° flood	RK-LX-XTM-REF-D40
60° wide flood	RK-LX-XTM-REF-D60

OPTICAL ACCESSORIES ▼ *See next page*



DIMMER OPERATION



OPTICAL ACCESSORIES

Specify as separate line items.

All are 3 3/4" (95mm) dia. Lenses and filters are glass; screens are aluminum.

55° spread lens	LENS/3.75
40° x 70° spread lens	LENS/3.75-4070
prismatic lens (Solite)	PLS/3.75
beam smoother included with fixture	CLR/3.75
color filters	
Daylight Blue	DAY/3.75
Surprise Pink	PNK/3.75
amber	AMB/3.75
blue	BLU/3.75
green	GRN/3.75
red	RED/3.75
33% light reduction screen	SCR33/3.75
50% light reduction screen	SCR50/3.75

MODIFICATIONS AVAILABLE

Contact factory with quantity for pricing; orders may require shop drawing approval.

For modified stem lengths up to 72", add the following to the end of the product code:
+ number of inches.

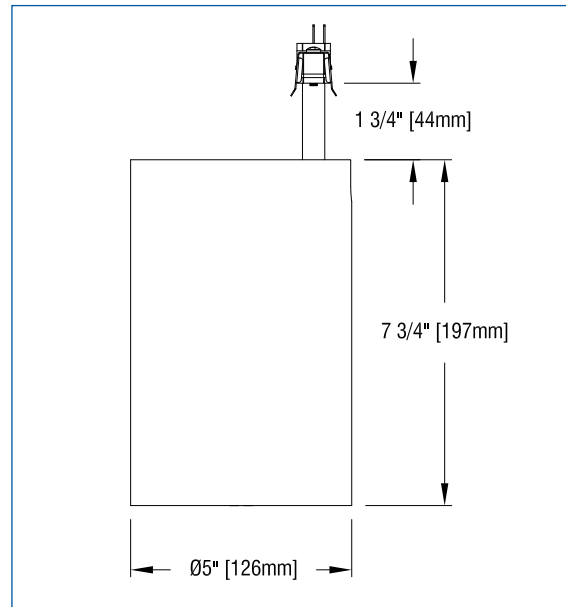

APPLICATIONS

Luminaire is suitable for highlighting vertical or horizontal surfaces, as well as objects in museums, galleries, showrooms, residences, offices and stores.

Luminaire is listed for mounting on Edison Price Lighting 120-volt or 277-volt track.

– see below for photometric reports –



PHOTOMETRIC REPORT with 20° reflector (tested per IESNA LM-79-2008)



UL Verification Services Report No. 1164149. Original test report furnished upon request.

Luminaire track-mounted LED accent light with a 20° reflector and black cross-baffle (NO LENS)
 Lamp Xicato XTM LED Module, 2100 lumens, 3000K
 Lamp Life rated 50.000 hours based on L70/B50 criteria. LM80 report by LED manufacturer furnished upon request

CANDLEPOWER DISTRIBUTION

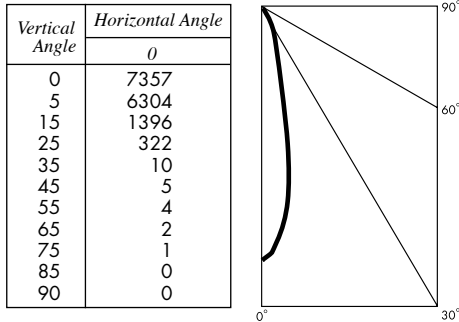

LUMINAIRE LIGHT OUTPUT AND EFFICACY

LED Module Type	Luminaire Light Output	Luminaire Efficacy (lms/watt)	System Wattage
2100 Lumens Artist	1072*	41*	26
2100 Lumens standard & Vibrant	1072	47	23
2700 Lumens standard & Vibrant	1351*	51*	26

*estimated values

PHOTOMETRIC REPORT with 40° reflector (tested per IESNA LM-79-2008)



UL Verification Services Report No. 1164150. Original test report furnished upon request.

Luminaire track-mounted LED accent light with a 40° reflector and black cross-baffle (NO LENS)
 Lamp Xicato XTM LED Module, 2100 lumens, 3000K
 Lamp Life see above

CANDLEPOWER DISTRIBUTION

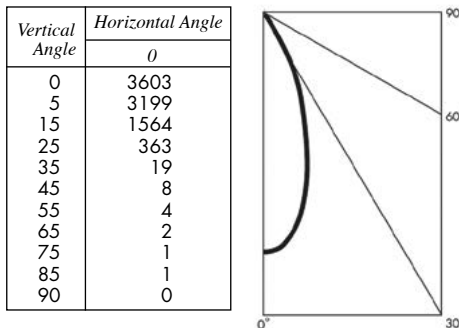

LUMINAIRE LIGHT OUTPUT AND EFFICACY

LED Module Type	Luminaire Light Output	Luminaire Efficacy (lms/watt)	System Wattage
2100 Lumens Artist	914*	35*	26
2100 Lumens standard & Vibrant	914	40	23
2700 Lumens standard & Vibrant	1152*	44*	26

*estimated values

PHOTOMETRIC REPORT with 60° reflector (tested per IESNA LM-79-2008)



UL Verification Services Report No. 1164151. Original test report furnished upon request.

Luminaire track-mounted LED accent light with a 60° reflector and black cross-baffle (NO LENS)
 Lamp Xicato XTM LED Module, 2100 lumens, 3000K
 Lamp Life see above

CANDLEPOWER DISTRIBUTION

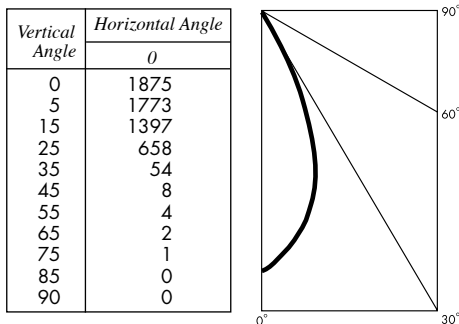

LUMINAIRE LIGHT OUTPUT AND EFFICACY

LED Module Type	Luminaire Light Output	Luminaire Efficacy (lms/watt)	System Wattage
2100 Lumens Artist	912*	35*	26
2100 Lumens standard & Vibrant	912	40	23
2700 Lumens standard & Vibrant	1149*	44*	26

*estimated values

PHOTOMETRIC REPORT with 20° reflector (tested per IESNA LM-79-2008)



UL Verification Services Report No. 1164146. Original test report furnished upon request.

Luminaire track-mounted LED accent light with a 20° reflector and black lens holder (NO LENS)

Lamp Xicato XTM LED Module, 2100 lumens, 3000K

Lamp Life rated 50.000 hours based on L70/B50 criteria. LM80 report by LED manufacturer furnished upon request

CANDLEPOWER DISTRIBUTION

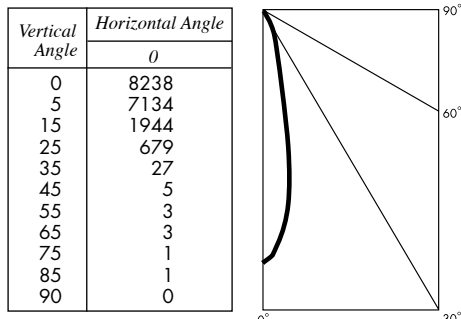

LUMINAIRE LIGHT OUTPUT AND EFFICACY

LED Module Type	Luminaire Light Output	Luminaire Efficacy (lms/watt)	System Wattage
2100 Lumens Artist	1480*	56*	26
2100 Lumens standard & Vibrant	1480	65	23
2700 Lumens standard & Vibrant	1865*	71*	26

*estimated values

PHOTOMETRIC REPORT with 40° reflector (tested per IESNA LM-79-2008)



UL Verification Services Report No. 1164147. Original test report furnished upon request.

Luminaire track-mounted LED accent light with a 40° reflector and black lens holder (NO LENS)

Lamp Xicato XTM LED Module, 2100 lumens, 3000K

Lamp Life see above

CANDLEPOWER DISTRIBUTION

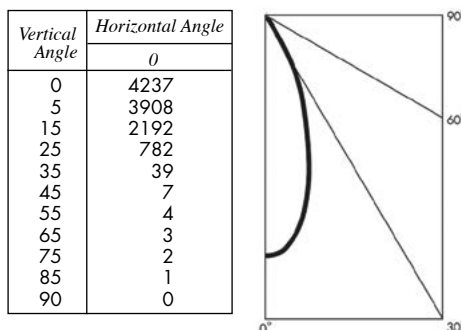

LUMINAIRE LIGHT OUTPUT AND EFFICACY

LED Module Type	Luminaire Light Output	Luminaire Efficacy (lms/watt)	System Wattage
2100 Lumens Artist	1366*	52*	26
2100 Lumens standard & Vibrant	1366	60	23
2700 Lumens standard & Vibrant	1721*	66*	26

*estimated values

PHOTOMETRIC REPORT with 60° reflector (tested per IESNA LM-79-2008)



UL Verification Services Report No. 1164148. Original test report furnished upon request.

Luminaire track-mounted LED accent light with a 60° reflector and black lens holder (NO LENS)

Lamp Xicato XTM LED Module, 2100 lumens, 3000K

Lamp Life see above

CANDLEPOWER DISTRIBUTION

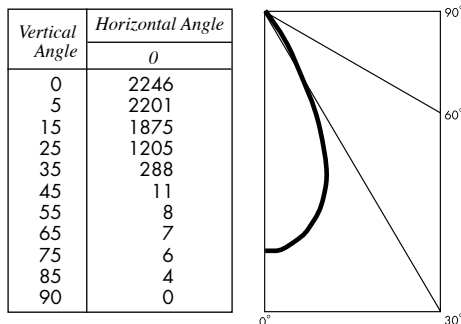

LUMINAIRE LIGHT OUTPUT AND EFFICACY

LED Module Type	Luminaire Light Output	Luminaire Efficacy (lms/watt)	System Wattage
2100 Lumens Artist	1489*	57*	26
2100 Lumens standard & Vibrant	1489	65	23
2700 Lumens standard & Vibrant	1876*	72*	26

*estimated values

STANDARD DRIVER INFORMATION (UL Class 2, dry and damp location)

Voltage	120	277
Input Watts (2100A/2100/2700 lumens)	26/23/26	26/18/26
Input Current(A) (2100A/2100/2700 lumens)	.22/.19/.22	.09/.08/.09
Output Current (mA)	700	700
Min. Power Factor	0.90	0.90
Operating Temperature Range (F)	-13 to 122	-13 to 122

LIGHT OUTPUT MULTIPLIER

LED Module Type	Light Output Multiplier
2100 Lumens Artist	1
2100 Lumens standard & Vibrant	1
2700 Lumens standard & Vibrant	1.26*