

Project

Type



Date

Product Code

Designer

IDM ARTIMA®/3 XTM O

track mounted LED accent light with integral dimmer



IDM Artima/3 O with Cross Baffle (OX)

IDM Artima/3 O with Open Aperture (OH)



aperture view



aperture view

- Fixtures may be configured to mount to any of eighteen 20-amp, 12-volt track systems – or – to any of six 277-volt track systems.
- Whether operated on 120-volt or 277-volt track, luminaire may be dimmed to 10% by an integral rotary dimmer located in the center of the housing top. Dimmer control shaft is spring loaded, permitting shaft to be expressed for adjustment and then depressed flush with the housing top, conserving dimmer setting. 'Clock face' markings permit registration of dimmer setting. (See illustrations below.)
- Bluetooth controls and integral rotary dimmer can be specified together in the same fixture. Users can dim by the protocol of their choice, switching between the two options as desired.
- Fixture function can be changed with your choice of Quick Change Cartridge – which can be removed from the fixture easily – and your choice of 'twist and lock' reflector.
- Quick Change Cartridge / Reflector choices
 - Quick Change Cartridge with a cross baffle (OX) for enhanced glare control; for use with a 20° 40° or 60° reflector
 - Quick Change Cartridge with an open aperture (OH) for maximum efficacy; for use with a 20°, 40° or 60° reflector
- Fixture is provided with a single Quick Change Cartridge and a single reflector. Additional Quick Change Cartridges and reflectors may be ordered as accessories.
- An on-off rocker switch, mounted in the driver case, is included on 120-volt fixtures.
- Optical Accessories: Each Quick Change Cartridge accepts one or two of a number of spread lenses, color filters and screens. A complimentary Beam Smoother is included.
- Horizontal and vertical adjustment can be locked by tightening two collar clamps using a 3/32" hex key.
- For more information, [click here](#).

For an outlet box mounted model, see [IDM Artima/3 XTM O-OBM](#).

IDM Artima/3 XTM O is a track mounted accent light powered by one of a number of 19mm Xicato LED modules. See tables below for wattages and efficacies.

PRODUCT CODE

For complete product code, list basic unit and select one item from each following box.

Basic Unit	IDM-A3-XTM
Track Configuration	
120-volt track (e.g. SightLine)	- 2C
277-volt track (e.g. HighLine)	- no switch; not dimmable - HC
Reflector (specify one to ship with fixture)	
20° spot	- 20D
40° flood	- 40D
60° wide flood	- 60D
Quick Change Cartridge	
Cross Baffle	- OX
Open Aperture	- OH
Finish	
white: white paint, white lead cord, matte aluminum heat sink; white switch	- WH
black: black paint, black lead cord, black heat sink; black switch	- BL
Industrial Silver: silver paint, black lead cord, black heat sink; black switch	- SI
custom color: include paint number or physical chip with order and select one from below	
• white lead cord, matte aluminum heat sink; white switch	- CCW
• black lead cord, black heat sink; black switch	- CCB
• any other combinations require a special order	
Light Source Output (Lumens)	
2100 lumens / CRI 98 Artist	- L21A
3000 lumens	- L30A
2100 lumens / CRI 90 Designer	- L21H
3000 lumens	- L30H
2100 lumens / CRI 80 Vibrant	- L21V
3900 lumens	- L39V
2100 lumens / CRI 80+ standard	- L21S
3900 lumens	- L39S
<i>Designer available in 2700K or 3000K. Vibrant available in 3000K only.</i>	
Light Color	
2700 K	- 27K
3000 K	- 30K
3500 K	- 35K
4000 K	- 40K
Dimming Notes:	
<ul style="list-style-type: none"> • Fixture may be dimmed only by its integral dimmer. • Fixture cannot be dimmed by a dimmer of any kind on the track circuit. • Fixture may be damaged by use of an incandescent or ELV dimmer on the track circuit. • Fixture will not be dimmed or damaged by use of a 0-10V dimmer on the track circuit. • Combination with wireless Bluetooth controls available on Bluetooth model. 	
EXTRA REFLECTORS & CARTRIDGES	
<i>Specify as separate line items.</i>	
Reflector	
20° spot reflector	XTM-REF20-72
40° spot reflector	XTM-REF40-72
60° spot reflector	XTM-REF60-72
Quick Change Cartridge	
Cross Baffle	A3-XTM-OX
Open Aperture	A3-XTM-OH



41-50 22ND STREET, LIC NY 11101 TEL 718.685.0700 FAX 718.786.8530 www.epl.com

©Copyright, Edison Price Lighting 2019
Artima is a registered trademark of Edison Price Lighting.

TF 11-173 2:20

OPTICAL ACCESSORIES ▼ See next page

DIMMER OPERATION

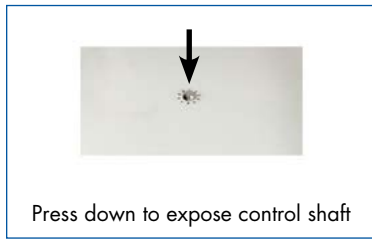

OPTICAL ACCESSORIES

Specify as separate line items.

All are 2 3/4" (70mm) dia. Lenses and filters are glass; screens are aluminum.

- diffuse glass DGS/2.75
- prismatic lens (Solite) PLS/2.75
- 55° spread lens LENS/2.75
- 40° x 70° spread lens LENS/2.75-4070
- beam smoother included with fixture CLR/2.75
- color filters**
- Daylight Blue DAY/2.75
- Surprise Pink PNK/2.75
- blue BLU/2.75
- green GRN/2.75
- red RED/2.75

BARN DOORS

Specify as separate line items.

Specify with one optical accessory (not included), see above.

- white BD-A3-WH
- black BD-A3-BL
- silver BD-A3-SI
- custom color BD-A3-CC

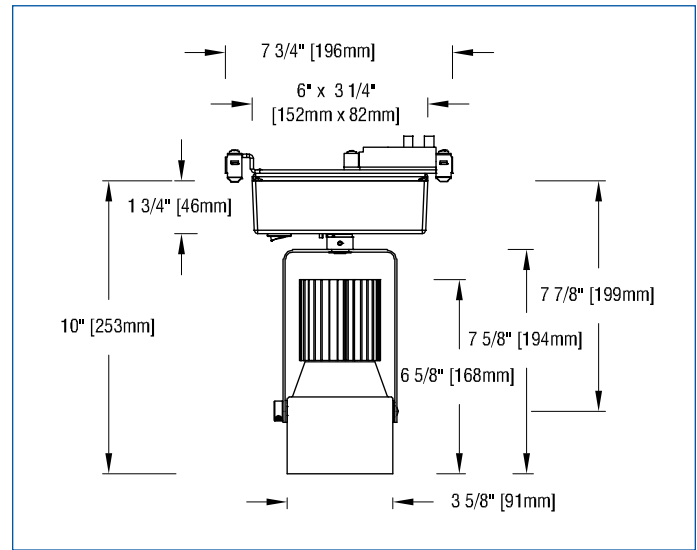

APPLICATIONS

Luminaire is suitable for highlighting vertical or horizontal surfaces, as well as objects in museums, galleries, showrooms, residences, offices and stores.

Luminaire is listed for mounting on Edison Price Lighting 120-volt or 277-volt track.

Fixture Spacing Requirements The track adapter of this fixture is 7 3/4" long. For this reason 1) it cannot be track-mounted closer than 8" on center and 2) it cannot be used with 2 of our 7 **Unicep** single-fixture track units.

STANDARD DRIVER INFORMATION (UL Class 2, dry and damp location)

Voltage	120	277
Input Watts (2100A/3000A/2100H/3000H/2100S&V/3900S&V lumens)	25/37/21/30/21/37	25/37/21/30/21/37
Input Current(A) (2100A/3000A/2100H/3000H/2100S&V/3900S&V lumens)	.21/.31/.18/.25/.18/.31	.09/.13/.08/.11/.08/.13
Min. Power Factor	0.90	0.90
Operating Temperature Range (F)	-13 to 122	-13 to 122

LIGHT OUTPUT MULTIPLIER

LED Module Type	Light Output Multiplier
2100 Lumens Artist	1.01*
3000 Lumens Artist	1.39*
2100 Lumens Designer	1*
3000 Lumens Designer	1.41*
2100 Lumens Standard & Vibrant	1
3900 Lumens Standard & Vibrant	1.78*

*estimated values

– photometrics continued below –



PHOTOMETRIC REPORT with 20° reflector (tested per IESNA LM-79-2008)

Prorated from Verification Services Report No. 1164149. Original test report furnished upon request.

Luminaire track-mounted LED accent light with a 20° reflector and black cross-baffle (NO LENS)
 Lamp Xicato XTM LED Module, 2100 lumens, 3000K
 Lamp Life rated 50.000 hours based on L70/B50 criteria. LM80 report by LED manufacturer furnished upon request



CANDLEPOWER DISTRIBUTION

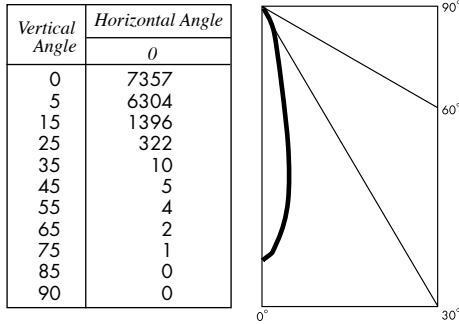

LUMINAIRE LIGHT OUTPUT AND EFFICACY

LED Module Type	Luminaire Light Output	Luminaire CBCP	Luminaire Efficacy (lms/watt)	System Wattage
2100 Lumens Artist	1083*	7491*	43*	25
3000 Lumens Artist	1490*	10310*	40*	37
2100 Lumens Designer	1072*	7417*	51*	21
3000 Lumens Designer	1512*	10458*	50*	30
2100 Lumens Standard & Vibrant	1072	7417	51	21
3900 Lumens Standard & Vibrant	1908*	13202*	52*	37

*estimated values

PHOTOMETRIC REPORT with 40° reflector (tested per IESNA LM-79-2008)

Prorated from Verification Services Report No. 1164150. Original test report furnished upon request.

Luminaire track-mounted LED accent light with a 40° reflector and black cross-baffle (NO LENS)
 Lamp Xicato XTM LED Module, 2100 lumens, 3000K Lamp Life see above

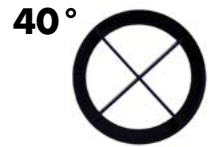

CANDLEPOWER DISTRIBUTION

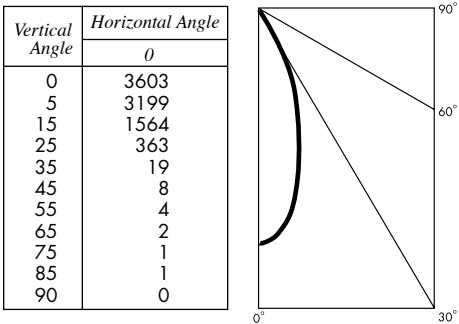

LUMINAIRE LIGHT OUTPUT AND EFFICACY

LED Module Type	Luminaire Light Output	Luminaire CBCP	Luminaire Efficacy (lms/watt)	System Wattage
2100 Lumens Artist	923*	3639*	37*	25
3000 Lumens Artist	1270*	5008*	34*	37
2100 Lumens Designer	914*	3603*	44*	21
3000 Lumens Designer	1289*	5080*	43*	30
2100 Lumens Standard & Vibrant	914	3603	44	21
3900 Lumens Standard & Vibrant	1627*	6413*	44*	37

*estimated values

PHOTOMETRIC REPORT with 60° reflector (tested per IESNA LM-79-2008)

Prorated from Verification Services Report No. 1164151. Original test report furnished upon request.

Luminaire track-mounted LED accent light with a 60° reflector and black cross-baffle (NO LENS)
 Lamp Xicato XTM LED Module, 2100 lumens, 3000K Lamp Life see above



CANDLEPOWER DISTRIBUTION

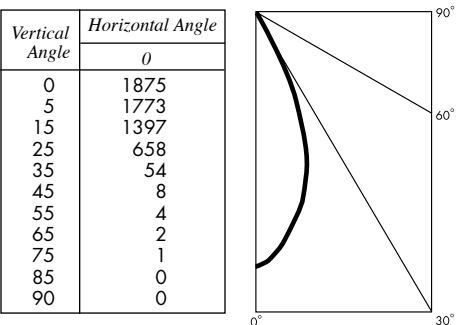

LUMINAIRE LIGHT OUTPUT AND EFFICACY

LED Module Type	Luminaire Light Output	Luminaire CBCP	Luminaire Efficacy (lms/watt)	System Wattage
2100 Lumens Artist	921*	1894*	37*	25
3000 Lumens Artist	1268*	2606*	34*	37
2100 Lumens Designer	912*	1875*	43*	21
3000 Lumens Designer	1286*	2644*	43*	30
3500 Lumens Designer	1459*	3000*	39*	37
2100 Lumens Standard & Vibrant	912	1875	43	21
3900 Lumens Standard & Vibrant	1623*	3338*	44*	37

*estimated values

PHOTOMETRIC REPORT with 20° reflector (tested per IESNA LM-79-2008)

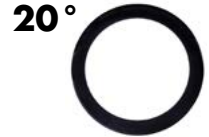

Prorated from Verification Services Report No. 1164146. Original test report furnished upon request.

Luminaire track-mounted LED accent light with a 20° reflector and black lens holder (NO LENS)

Lamp Xicato XTM LED Module, 2100 lumens, 3000K

Lamp Life rated 50.000 hours based on L70/B50 criteria. LM80 report by LED manufacturer furnished upon request

CANDLEPOWER DISTRIBUTION

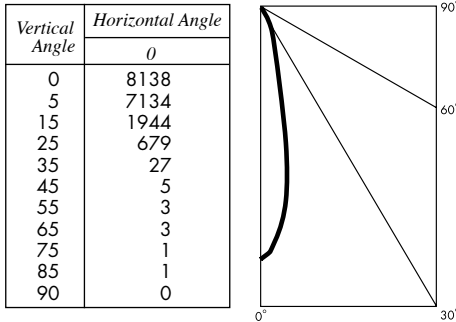

LUMINAIRE LIGHT OUTPUT AND EFFICACY

LED Module Type	Luminaire Light Output	Luminaire CBCP	Luminaire Efficacy (lms/watt)	System Wattage
2100 Lumens Artist	1495*	8219*	60*	25
3000 Lumens Artist	2057*	11312*	56*	37
2100 Lumens Designer	1480*	8138*	70*	21
3000 Lumens Designer	2087*	11475*	70*	30
2100 Lumens Standard & Vibrant	1480	8138	70	21
3900 Lumens Standard & Vibrant	2634*	14486*	71*	37

*estimated values

PHOTOMETRIC REPORT with 40° reflector (tested per IESNA LM-79-2008)



Prorated from Verification Services Report No. 1164147. Original test report furnished upon request.

Luminaire track-mounted LED accent light with a 40° reflector and black lens holder (NO LENS)

Lamp Xicato XTM LED Module, 2100 lumens, 3000K Lamp Life see above

CANDLEPOWER DISTRIBUTION

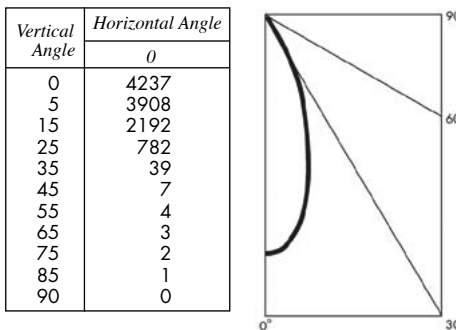

LUMINAIRE LIGHT OUTPUT AND EFFICACY

LED Module Type	Luminaire Light Output	Luminaire CBCP	Luminaire Efficacy (lms/watt)	System Wattage
2100 Lumens Artist	1380*	4279*	55*	25
3000 Lumens Artist	1899*	5889*	51*	37
2100 Lumens Designer	1366*	4237*	65*	21
3000 Lumens Designer	1926*	5974*	64*	30
2100 Lumens Standard & Vibrant	1366	4237	65	21
3900 Lumens Standard & Vibrant	2431*	7542*	66*	37

*estimated values

PHOTOMETRIC REPORT with 60° reflector (tested per IESNA LM-79-2008)



Prorated from Verification Services Report No. 1164148. Original test report furnished upon request.

Luminaire track-mounted LED accent light with a 60° reflector and black lens holder (NO LENS)

Lamp Xicato XTM LED Module, 2100 lumens, 3000K Lamp Life see above

CANDLEPOWER DISTRIBUTION

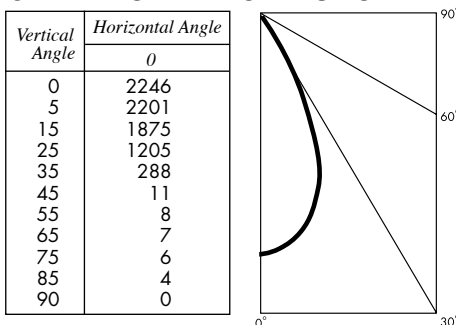

LUMINAIRE LIGHT OUTPUT AND EFFICACY

LED Module Type	Luminaire Light Output	Luminaire CBCP	Luminaire Efficacy (lms/watt)	System Wattage
2100 Lumens Artist	1504*	2268*	60*	25
3000 Lumens Artist	2070*	3122*	56*	37
2100 Lumens Designer	1489*	2246*	71*	21
3000 Lumens Designer	2099*	3167*	70*	30
2100 Lumens Standard & Vibrant	1489*	2246*	71*	21
3900 Lumens Standard & Vibrant	2650*	3998*	72*	37

*estimated values