

PRESTO™ THREE LED AA

recessed LED accent light remodeler



PRECISE OPTICS - PRECISE OPTICS - PRECISE OPTICS - PRECISE OPTICS - PRECISE OPTICS

FEATURES

- **Presto Three LED AA is a 3" aperture, LED remodeler accent light.** Recess depth is 6 7/8" to 7 3/4", varying directly with ceiling thickness.
- **Luminaire is powered by a Xicato® XTM (19mm) LED module,** distinguished by extraordinary color consistency (within 1 x 2 -step MacAdam ellipse). See tables on the next page for luminaire wattages and efficacies.
- **Luminaire may be ordered with one of a number of drivers.**
- **Luminaire includes an internal reflector to produce a 36° or 54° beam-spread.** To allow beamspread to be changed after installation, internal reflectors are also available as accessories. Luminaire provides 0 – 45° angular adjustment and 50° rotation. Once focused, adjustment can be locked in place by means of a thumb nut.
- **External reflector design minimizes aperture brightness.** Standard external reflector, cut at 25°, is designed for maximum tilt; optional external reflectors, cut at 0° and 15°, are also available.
- **Reflectors are available in two clear natural aluminum colors** – slightly diffuse (V) or fully diffuse (EC) – as well as champagne gold or black Alzak®. Other finishes are available on special order. A LightPlate trim may be used instead of a reflector.
- **Luminaire includes, within its reflector assembly, a holder permitting the use of one of a number of Optical Accessories** including spread lenses and color filters. A beam smoother is included.
- **Trim flange conceals edges of ceiling installation hole.** Standard finish is white; custom paint finish available on special order.
- **Frame is constructed from 14-gauge electro-zinc steel** in Edison Price Lighting's American factory.
- **For more information, click here.**



APPLICATIONS

Installation locations should offer the following conditions:

- ceiling material 2" or less thick capable of supporting at least 16 pounds
- recess depth of 7 3/8" to 8 1/4", varying directly with ceiling thickness
- plenum free of joists or obstructions for as much as 6 7/8" to either side to accommodate 'legs' of frame and as much as 13" to one side to accommodate junction box, varying directly with ceiling thickness.

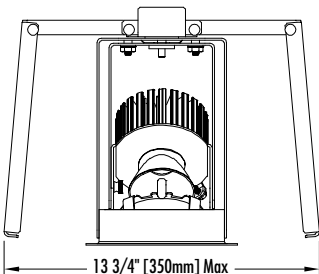

Luminaire is listed for Damp Location, RoHA compliant and prewired with a thermal protector. Removal of the reflector allows access to the LED array, driver and junction box.

Flush trim model, see [PRESTINA THREE LED AA](#)
 Standard recessed, see [THREE XTM AA](#)
 IC-rated, see [EPIC THREE XTM AA](#)
 For retrofit LED lamp, see [PRESTO THREE MRE AA](#)

MODIFICATIONS AVAILABLE ▼ See next page

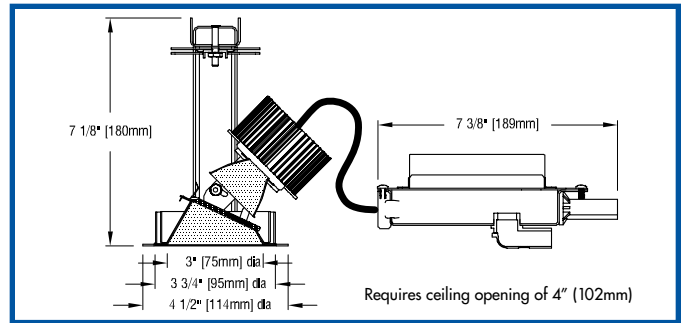

PRODUCT CODE

For complete product code, list basic unit and select one item from each following box.

Basic Unit.....	PST-XTM-3AA
Custom painted trim flange available on special order. Add -CC	
Internal Reflector <i>Choose one.</i>	
36° flood.....	- 36D
54° wide flood	- 54D
Driver	
dimmable to 1% with a 0-10V dimmer on 120 or 277-volt service.....	- DMV
dimmable to 10% with either an incandescent or electronic low voltage (ELV) dimmer on 120-volt service only; not suitable for 700 lumen source (L07A)	- DMP
Light Source Output	
700 lumens /CRI 98 Artist	DMP driver not available
1000 lumens /CRI 98 Artist	L10A
1000 lumens /CRI 83	L10S
1000 lumens /CRI 83 Vibrant	3000K only
1300 lumens /CRI 98 Artist	L13A
1300 lumens /CRI 83	L13S
1300 lumens /CRI 83 Vibrant	3000K only
1600 lumens /CRI 98 Artist	L16A
1600 lumens /CRI 83	L16S
1600 lumens /CRI 83 Vibrant	3000K only
Voltage	120 or 277
Light Engine Color	
2700K	- 27K
3000K	- 30K
3500K	- 35K
4000K	- 40K
Reflector Color and Detail	
Semi-specular Clear	CTF
Slightly diffuse Clear	VTF
Fully diffuse Clear	ECTF
Champagne Gold	CTF
Black	BTf
Other reflector finishes available on special order.	
<i>LightPlates may be ordered instead of the standard reflectors above (see next page).</i>	
LightPlate Downlight Spot , white	DP3-TF
LightPlate Accent Spot , white	AP3-TF
LightPlate Accent Slot , white	AL3-TF
Custom painted trims for LightPlate are available on special order. Add -CC	

OPTIONS

Specify by adding to the basic unit.

0° cut reflector (standard reflector is 25° cut)	-0
15° cut reflector (standard reflector is 25° cut)	-15

EXTRA REFLECTORS

Specify as a separate line item.

36° flood internal reflector	XTM-REF36-50
54° wide flood internal reflector	XTM-REF54-50

► Kits are available on special order for the field conversion of this luminaire to an accent light or wallwasher. Contact factory.

OPTICAL ACCESSORIES

▼ See next page



MODIFICATIONS AVAILABLE Contact factory with quantity for pricing; orders may require shop drawing approval.

- +DOD:** luminaire suitable for **high humidity** environments; add +DOD to Product Code.
- +MAR:** reflector suitable for **marine** environments; add +MAR to Product Code.

LIGHTPLATES *LightPlates may be used instead of standard reflectors.*

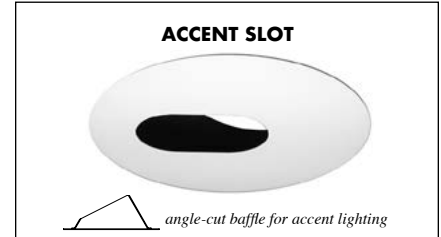
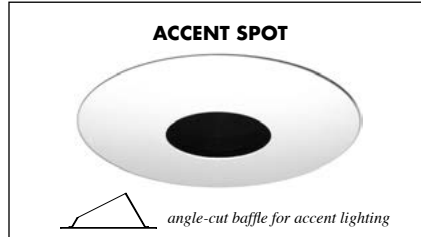
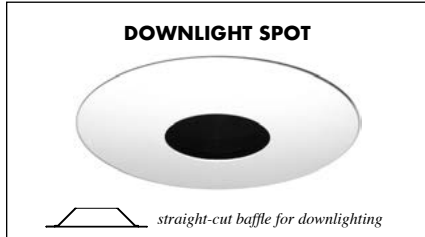

OPTICAL ACCESSORIES *Specify as separate line*

All are 2 3/8" (60mm) diameter.

diffuse glass	DGS/2.375
prismatic lens (Solite)	PLS/2.375
55° spread lens	LENS/2.375
40° x 70° spread lens	LENS/2.375-4070
beam smoother (included with fixture)	DIF05/2.375
33% light reduction screen	SCR33/2.375
50% light reduction screen	SCR50/2.375

color filters

surprise pink	PNK/2.375
daylight blue	DAY/2.375
amber	AMB/2.375
blue	BLU/2.375
green	GRN/2.375
red	RED/2.375

See below for photometric reports



PHOTOMETRIC REPORT with 36° reflector (tested per IESNA LM-79-2008)

Verification Services Report No. 1188772. Original test report furnished upon request.

Luminaire recessed LED round accent light with semi-specular clear aluminum reflector, LED aimed at 15° above vertical
 Light Source one white Xicato XTM 19mm LES LED with 36° beam spread integral reflector, 3000K CCT, 80 CRI, 1600 lumens

CANDLEPOWER DISTRIBUTION (Candela)

Vertical Angle	Horizontal Angle				
	0	45	90	135	180
0	1739	1739	1739	1739	1739
5	2604	2294	1572	1039	817
15	3036	2195	603	84	27
25	2642	1048	39	6	5
35	677	92	5	3	2
45	5	3	1	2	2
55	2	1	1	1	2
65	1	0	0	0	0
75	0	0	0	0	0
85	0	0	0	0	0
90	0	0	0	0	0

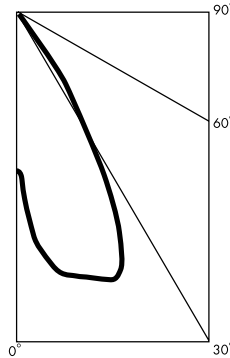

LUMINAIRE LIGHT OUTPUT AND EFFICACY

LED Light Engine	Luminaire Light Output	Luminaire Efficacy (lms/watt)	System Wattage
700 Lumens Artist	371*	31*	12
1000 Lumens Artist	493*	29*	17
1300 Lumens Artist	657*	31*	21
1600 Lumens Artist	793*	36*	22
1000 Lumens standard & Vibrant	497*	41*	12
1300 Lumens standard & Vibrant	664*	39*	17
1600 Lumens standard & Vibrant	801	45	19

*estimated values

PHOTOMETRIC REPORT with 54° reflector (tested per IESNA LM-79-2008)

Verification Services Report No. 1188773. Original test report furnished upon request.

Luminaire recessed LED round accent light with semi-specular clear aluminum reflector, LED aimed at 15° above vertical
 Light Source one white Xicato XTM 19mm LES LED with 54° beam spread integral reflector, 3000K CCT, 80 CRI, 1600 lumens

CANDLEPOWER DISTRIBUTION (Candela)

Vertical Angle	Horizontal Angle				
	0	45	90	135	180
0	974	974	974	974	974
5	1483	1263	883	616	497
15	1960	1221	374	54	12
25	1869	934	107	5	4
35	1334	488	11	3	2
45	295	50	4	4	2
55	2	2	3	4	4
65	1	0	1	1	2
75	0	0	0	0	0
85	0	0	0	0	0
90	0	0	0	0	0

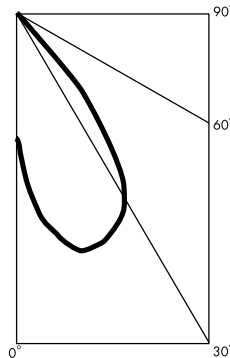

LUMINAIRE LIGHT OUTPUT AND EFFICACY

LED Light Engine	Luminaire Light Output	Luminaire Efficacy (lms/watt)	System Wattage
700 Lumens Artist	328*	27*	12
1000 Lumens Artist	435*	26*	17
1300 Lumens Artist	583*	28*	21
1600 Lumens Artist	700	32*	22
1000 Lumens standard & Vibrant	439*	37*	12
1300 Lumens standard & Vibrant	589*	35*	17
1600 Lumens standard & Vibrant	707	37	19

*estimated values

STANDARD DMV DRIVER INFORMATION (UL Class 2, dry and damp location)

Voltage	120	277
Input Watts (L07A/L10A/L13A/L16A/L10S&V/L13S&V/L16S&V)	12/17/21/22/12/17/19	12/17/21/22/12/17/19
Input Current (A) (L07A/L10A/L13A/L16A/L10S&V/L13S&V/L16S&V)	.10/.14/.18/.18/.08/10/.14	.04/.06/.08/.08/.04/.04/.06
Output Current (mA)	350-700	350-700
Min. Power Factor	.99	.99
Operating Temperature Range (F)	-13 to 122	-13 to 122

LIGHT OUTPUT MULTIPLIER

LED Light Engine	Light Output Multiplier
700 Lumens Artist	.46*
1000 Lumens Artist	.61*
1300 Lumens Artist	.82*
1600 Lumens Artist	.99*
1000 Lumens standard & Vibrant	.62*
1300 Lumens standard & Vibrant	.83*
1600 Lumens standard & Vibrant	1.0

*estimated values

REFLECTOR COLOR MULTIPLIERS

Semi-specular clear (C)	1
Slightly diffuse clear (V)	.95
Fully diffuse clear (EC)	.88
Champagne gold clear (G)	.95
Black (B)	.49