

Project

Type



Date

Product Code

Designer

PRESTINA™ FOUR LED AA

recessed LED accent light trim flush remodeler

PRECISE OPTICS - PRECISE OPTICS - PRECISE OPTICS - PRECISE OPTICS - PRECISE OPTICS - PRECISE OPTICS - PRECISE OPTICS

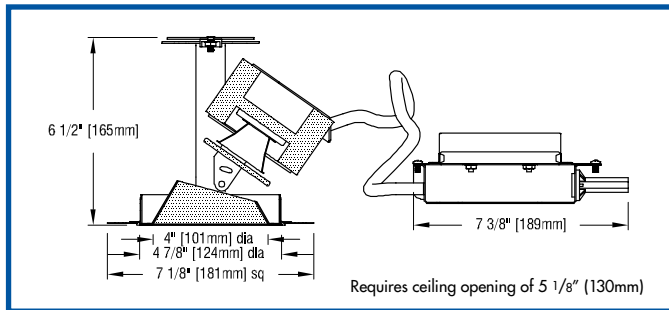

FEATURES

- **Prestina FOUR LED AA is a 4" aperture LED remodeler accent light** designed for installation from below in a sheet rock ceiling to achieve a flush reflector trim detail. Installation includes the application of drywall compound over the integral spackle screen to the rim of the integral plaster ring.
- **Luminaire is powered by one of a number of Xicato® XTM 19mm modules – including Artist Series and Vibrant Series modules** – all of which are distinguished by extraordinary color consistency (within 1x 2-step MacAdam ellipse). See tables below for wattages and efficiencies.
- **Luminaire provides 0°-35° angular adjustment (tilt) and 50° rotation.** Once focused, adjustment can be locked in place by means of a wing nut.
- **Luminaire includes an internal reflector to produce a 36° or 54° beam spread.** To allow beam spread to be changed after installation, internal reflectors are also available as accessories.
- **Luminaire may be ordered with a number of drivers.**
- **Luminaire accepts one of a number of available Optical Accessories including lenses and color filters.** A complimentary Beam Smoother is included.
- **Reflectors are available in three clear natural aluminum finishes** — semi-specular (C), slightly diffuse (V) or fully diffuse (EC) — as well as champagne gold or black Alzak®. Other finishes available on special order. LightPlate™ decorative trims may be ordered instead of reflectors.
- **For more information, [click here](#).**

APPLICATIONS

Installation locations should offer the following conditions:

- ceiling material 2" or less thick capable of supporting 16 pounds
- recess depth of at least 6 1/2"
- plenum free of joists or obstructions for at least 11" from center along one side (to accommodate junction box).

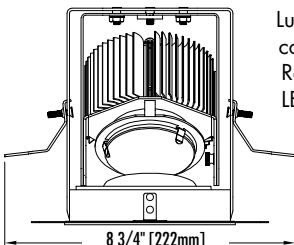

Luminaire is listed for Damp Location, RoHA compliant and prewired with a thermal protector. Removal of the reflector allows access to the LED array, driver and junction box.

Overlap trim model, see [PRESTO FOUR LED AA](#)
 Standard recessed, see [FOUR HI AA](#)
 For higher efficacies, see [PRESTINA WAFER/4 AA](#)
 For retrofit LED lamp, see [PRESTINA MRE/4 AA](#)

PRODUCT CODE

For complete product code, list basic unit and select one item from each following box.

Basic Unit.....	PST-XTM-4AA-TFR
Internal Reflector	
36° initial beamspread	- 36D
54° initial beamspread	- 54D
Light Source Output	
700 lumens / CRI 98 Artist	<i>DMP driver not available</i> - L07A
1000 lumens / CRI 98 Artist	- L10A
1000 lumens / CRI 80+.....	- L10S
1000 lumens / CRI 80+ Vibrant	<i>3000K only</i> - L10V
1300 lumens / CRI 98 Artist	- L13A
1300 lumens / CRI 80+	- L13S
1300 lumens / CRI 80+ Vibrant	<i>3000K only</i> - L13V
1600 lumens / CRI 98 Artist	- L16A
1600 lumens / CRI 80+.....	- L16S
1600 lumens / CRI 80+ Vibrant	<i>3000K only</i> - L16V
2000 lumens / CRI 80+.....	- L20S
2000 lumens / CRI 80+ Vibrant	<i>3000K only</i> - L20V
2100 lumens / CRI 98 Artist	- L21A
2700 lumens / CRI 80+.....	- L27S
2700 lumens / CRI 80+ Vibrant	<i>3000K only</i> - L27V
Light Color	
2700 K.....	- 27K
3000 K.....	- 30K
3500 K	- 35K
4000 K.....	- 40K
Driver	
dimmable to 1% by a 0-10V dimmer on 120 or 277-volt service	- DMV
dimmable to 5% by either an incandescent or ELV dimmer; 120-volt service only; not suitable for 700 lumen source (L07A).....	- DMP
eldoLED 0-10V (Logarithmic) driver dimmable to 0.1% with a 0-10V dimmer on 120 or 277-volt service	- DVOELG
eldoLED 0-10V (Linear) driver dimmable to 0.1% with a 0-10V dimmer on 120 or 277-volt service	- DVOELN
eldoLED driver dimmable to 0.1%, compatible with Dali control system	- DA0-EL
Voltage	
120 volt.....	- 120
277 volt.....	- 277
Reflector Color	
Semi-specular Clear	- EE-CTF
Slightly diffuse Clear	- EE-VTF
Fully diffuse Clear	- EE-ECTF
Champagne Gold.....	- EE-GTF
Black	- EE-BTF
Other reflector finishes available on special order.	
<i>LightPlate decorative trims (see over) may be ordered instead of the standard reflectors above.</i>	
LightPlate Downlight Spot , white	- DP-TF
LightPlate Accent Spot , white	- AP-TF
LightPlate Accent Slot , white	- AL-TF
Custom painted LightPlates available on special order. Add -CC	

EXTRA REFLECTORS *Specify as separate line items.*

36° internal reflector	XTM-REF36-50
54° internal reflector	XTM-REF54-50

OPTICAL ACCESSORIES ▼ See next page





LIGHTPLATES LightPlates may be used instead of standard reflectors.

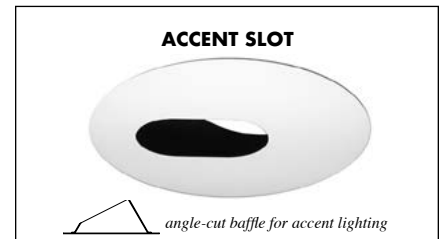
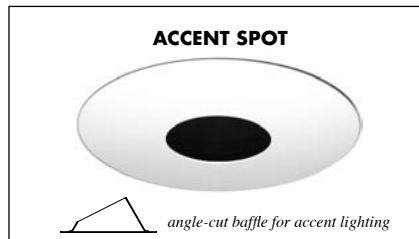
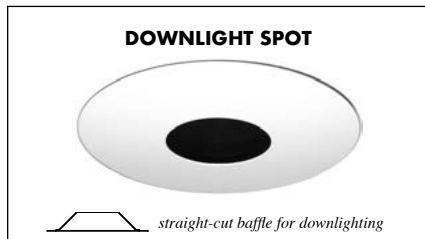

OPTICAL ACCESSORIES Specify as separate line

All are 2 3/4" (70mm) diameter.

diffuse glass	DGS/2.75
prismatic lens (Solite)	PLS/2.75
55° spread lens	LENS/2.75
40° x 70° spread lens	LENS/2.75-4070
beam smoother	(included with fixture)..... DIF05/2.75
33% light reduction screen	SCR33/2.75
50% light reduction screen	SCR50/2.75

color filters

surprise pink	PNK/2.75
daylight blue.....	DAY/2.75
amber	AMB/2.75
blue	BLU/2.75
green	GRN/2.75
red	RED/2.75

See below for photometric reports



PHOTOMETRIC REPORT with 36° reflector (tested per IESNA LM-79-2008)

Verification Services Report No. 1173020. Original test report furnished upon request.

Luminaire recessed LED round accent light with semi-specular clear aluminum reflector, LED aimed at 15° above vertical
 Light Source one white Xicato XTM 19mm LES LED with 36° beam spread integral reflector, 3000K CCT, 80 CRI, 2000 lumens

CANDLEPOWER DISTRIBUTION (Candela)

Vertical Angle	Horizontal Angle				
	0	45	90	135	180
0	2186	2186	2186	2186	2186
5	2954	2663	2065	1643	1509
15	3556	2758	1404	773	614
25	2954	1797	683	138	25
35	1509	881	95	4	2
45	614	243	4	1	0
55	25	5	1	0	0
65	2	1	0	0	0
75	0	0	0	0	0
85	0	0	0	0	0
90	0	0	0	0	0

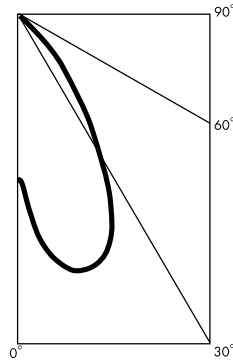

LUMINAIRE LIGHT OUTPUT AND EFFICACY

LED Light Engine	Luminaire Light Output	Luminaire Efficacy (lms/watt)	System Wattage
700 Lumens Artist	571*	46*	12
1000 Lumens Artist	757*	45*	17
1300 Lumens Artist	1000*	47*	21
1600 Lumens Artist	1216*	56*	22
2100 Lumens Artist	1614*	55*	29
1000 Lumens standard & Vibrant	765*	62*	12
1300 Lumens standard & Vibrant	1020*	61*	17
1600 Lumens standard & Vibrant	1232*	63*	19
2000 Lumens standard & Vibrant	1562	72	22
2700 Lumens standard & Vibrant	2036*	70*	29

*estimated values

PHOTOMETRIC REPORT with 54° reflector (tested per IESNA LM-79-2008)

Verification Services Report No. 1173021. Original test report furnished upon request.

Luminaire recessed LED round accent light with semi-specular clear aluminum reflector, LED aimed at 15° above vertical
 Light Source one white Xicato XTM 19mm LES LED with 54° beam spread integral reflector, 3000K CCT, 80 CRI, 2000 lumens

CANDLEPOWER DISTRIBUTION (Candela)

Vertical Angle	Horizontal Angle				
	0	45	90	135	180
0	1736	1736	1736	1736	1736
5	1871	1824	1701	1540	1479
15	1997	1840	1425	915	782
25	1871	1607	843	311	157
35	1479	1010	262	3	2
45	782	411	2	1	0
55	157	3	1	0	0
65	2	1	0	0	0
75	0	0	0	0	0
85	0	0	0	0	0
90	0	0	0	0	0

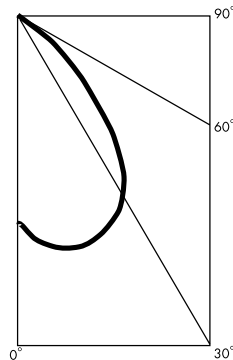

LUMINAIRE LIGHT OUTPUT AND EFFICACY

LED Light Engine	Luminaire Light Output	Luminaire Efficacy (lms/watt)	System Wattage
700 Lumens Artist	540*	44*	12
1000 Lumens Artist	717*	43*	17
1300 Lumens Artist	947*	45*	21
1600 Lumens Artist	1151*	53*	22
2100 Lumens Artist	1528*	52*	29
1000 Lumens standard & Vibrant	724*	58*	12
1300 Lumens standard & Vibrant	966*	57*	17
1600 Lumens standard & Vibrant	1166*	60*	19
2000 Lumens standard & Vibrant	1479	68	22
2700 Lumens standard & Vibrant	1928*	66*	29

*estimated values

STANDARD DMV DRIVER INFORMATION (UL Class 2, dry and damp location)

Voltage	120	277
Input Watts (L07A/L10A/L13A/L16A/L21A/L10S&V/L13S&V/L16S&V/L20S&V/L27S&V)	12/17/21/22/29/12/17/19/22/29	12/17/21/22/29/12/17/19/22/29
Input Current (A) (L07A/L10A/L13A/L16A/L21A/L10S&V/L13S&V/L16S&V/L20S&V/L27S&V)	.10/14/18/18/24/10/14/16/18/24	.04/06/08/08/10/04/06/07/08/10
Output Current (mA)	350-700	350-700
Min. Power Factor	.99	.99
Operating Temperature Range (F)	-13 to 122	-13 to 122

LIGHT OUTPUT MULTIPLIER

LED Light Engine	Light Output Multiplier
700 Lumens Artist	.37*
1000 Lumens Artist	.48*
1300 Lumens Artist	.64*
1600 Lumens Artist	.78*
2100 Lumens Artist	1.03*
1000 Lumens standard & Vibrant	.49*
1300 Lumens standard & Vibrant	.65*
1600 Lumens standard & Vibrant	.79*
2000 Lumens standard & Vibrant	1
2700 Lumens standard & Vibrant	1.30*

*estimated values

REFLECTOR COLOR MULTIPLIERS

Semi-specular clear (C)	1
Slightly diffuse clear (V)	.95
Fully diffuse clear (EC)	.88
Champagne gold clear (G)	.95
Black (B)	.49